

The Kiernan Reentry Measurements System on Kwajalein Atoll

The Kiernan Reentry Measurements System (KREMS), located on Kwajalein Atoll in the Pacific, is the United States' most sophisticated and important research and development (R & D) radar site. Consisting of four one-of-a-kind instrumentation radars, KREMS has played a major role for the past 25 years in the collection of data associated with ICBM testing. Furthermore, it has served as an important space-surveillance facility that provides an early U.S. view of many Soviet and Chinese satellite launches. Finally, the system is slated to play a key role in Strategic Defense Initiative (SDI) experiments.

Kwajalein Atoll, which rests 9° north of the equator and 3,500 km southwest of Hawaii, is a necklacelike strand of islands remotely located in the Pacific Ocean. Situated 7,000 km down-range from Vandenberg Air Force Base in California (Fig. 1), Kwajalein is also the location of the Kiernan Reentry Measurements System (KREMS)—the United States' most sophisticated and important R & D radar site. KREMS includes four unique, high-power, precision radars:

ALTAIR (ARPA Long-Range Tracking and Instrumentation Radar),

TRADEX (Target Resolution and Discrimination Experiment),

ALCOR (ARPA-Lincoln C-Band Observables Radar),

MMW (Millimeter Wave).

(See the box "Acronyms.") Figure 2, a recent aerial photograph of Roi-Namur, the northernmost island of the atoll, shows the location of the four radars.

Lincoln Laboratory, under the sponsorship of the United States Army Kwajalein Atoll (USAKA), has been the scientific director of KREMS since the radar system's inception in 1959. (See the box "A Brief History of KREMS.") In this capacity, the Laboratory's responsibilities include scheduling the system's operation to support various user requirements; verifying the calibration of the sensors; and validating,

reducing, and publishing the data collected. In addition, the Laboratory plans the upgrades, performs the systems engineering, and oversees the implementation of modifications.

To assist the Laboratory, two contractors have built the radars and are responsible for operating, maintaining, and modifying them. GE Government Electronic Systems Division (formerly a part of RCA Corp.) is responsible for TRADEX, ALCOR, and MMW, while GTE Government Systems Corp. (formerly Sylvania) is responsible for ALTAIR.

KREMS's primary objective is to collect and record high-quality metric and signature radar data in support of a wide variety of user requirements. (In the context of this article, metric data is information about a target's position and velocity. Signature data is information regarding the scattering characteristics of a target.) KREMS's broad scope of functions reflects the system's national-range status in the Strategic Defense Command. The radar system's functions support five areas:

- (1) missile system development and operational testing;
- (2) space surveillance, tracking, and object identification;
- (3) discrimination research;
- (4) ballistic-missile defense (BMD) component and system tests;

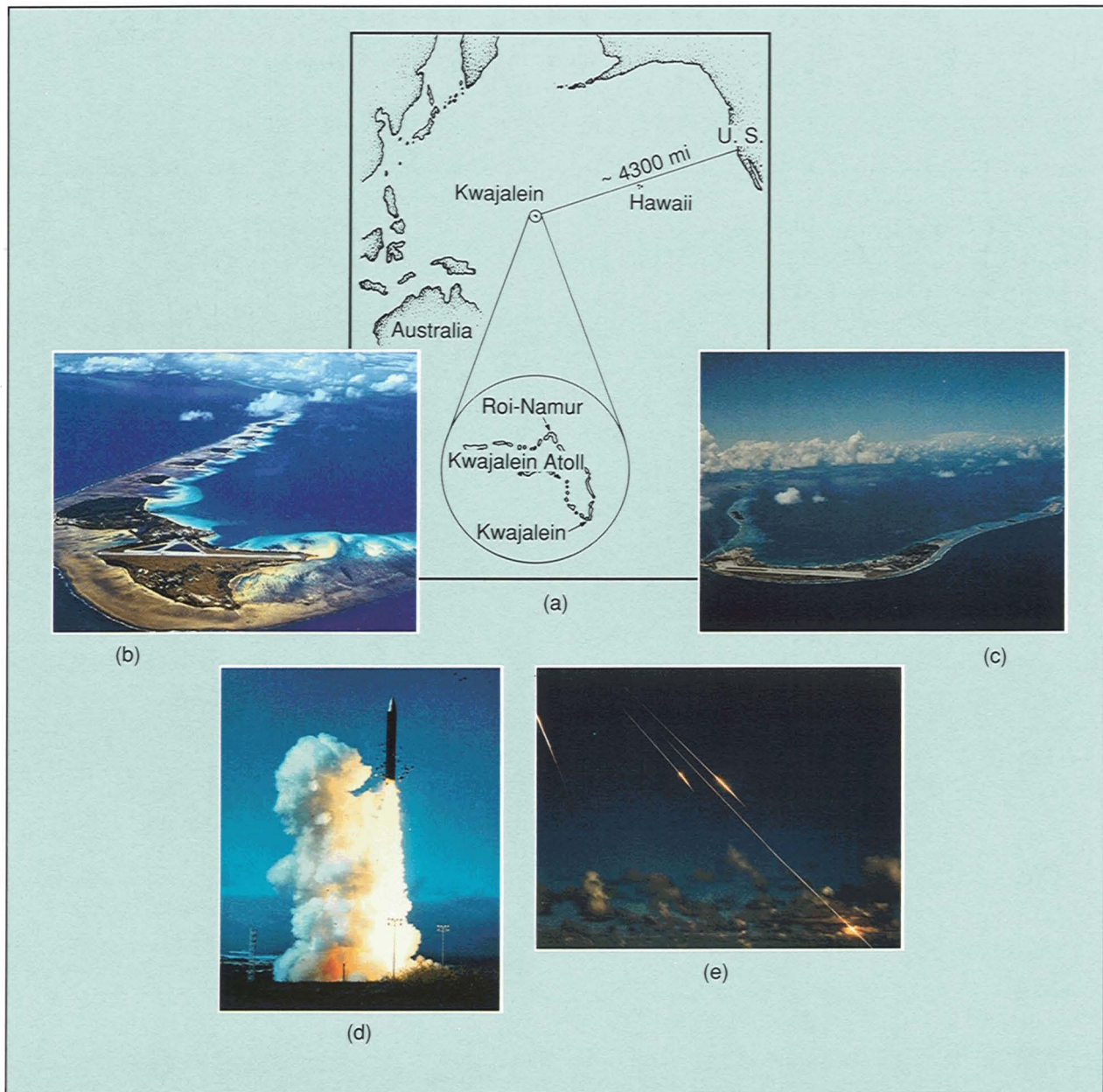

Fig. 1—(a) Map showing location of Kwajalein Atoll, which encircles the world's largest lagoon. (b) Roi-Namur Island. (c) Kwajalein Island. (d) Missile launch from Vandenberg Air Force Base in California. (e) Missile reentry at Kwajalein.

(5) scientific research.

The first support area involves collection of data on missile system components. These components include reentry vehicles (RV), penetration aids such as decoys and metallic-foil chaff, and delivery systems such as post-boost vehicles (PBV)—platforms used to carry and deploy RVs. KREMS provides these data to

the Air Force Ballistic Systems Division, the Strategic Air Command, and the Navy. The data are used to evaluate systems as they evolve from the development stage through operational readiness.

The responsibilities of the second support area are detecting and tracking new foreign launches (NFL), imaging foreign and domestic

Acronyms

A/D	analog to digital	MMS	Multistatic Measurement System
ALCOR	ARPA-Lincoln C-Band Observables Radar	MMW	Millimeter Wave
ALTAIR	ARPA Long-Range Tracking and Instrumentation Radar	MTT	multitarget tracker
AOS	Army Optical Station	NFL	new foreign launch
ARPA	Advanced Research Projects Agency	PACBAR	Pacific Barrier
ARS	ALTAIR Recording System	PBV	post-boost vehicle
BMD	ballistic-missile defense	PPS	pulses per second
BWG	beam waveguide	PRF	pulse-repetition frequency
CMOS	complementary metal-oxide semiconductor	PRESS	Pacific Range Electromagnetic Signature Studies
CPU	central processing unit	RADOT	recording automatic digital optical tracker
CW	continuous wave	RC	right circular
DARPA	Defense Advanced Research Projects Agency	RCS	radar cross section
dBsm	decibels referred to 1 square meter	R & D	research and development
ERIS	Exoatmospheric Reentry Vehicle Interceptor System	RF	radio frequency
FJB	frequency jumped burst	RLOS	radar line of sight
GBM	ground-based measurements	rms	root mean square
HEDI	High Endoatmospheric Defense Interceptor	RV	reentry vehicle
HOE	Homing Overlay Experiment	SATKA	Surveillance, Acquisition, Track, and Kill Assessment
ICBM	intercontinental ballistic missile	SDI	Strategic Defense Initiative
IF	intermediate frequency	SIE	SATKA Integrated Experiments
KCC	KREMS Control Center	SIMPAR	Simulate the Perimeter Acquisition Radar
KDS	Kwajalein Discrimination System	SNR	signal-to-noise ratio
KREMS	Kiernan Reentry Measurements System	SOI	Space Object Identification
LC	left circular	SPADATS	Space Detection and Tracking System
LITE	Laser Infrared Tracking Experiment	TRADEX	Target Resolution and Discrimination Experiment
		TWT	traveling-wave tube
		USAKA	United States Army Kwajalein Atoll
		USP	Universal Signal Processor

near-earth satellites (the Space Object Identification, or SOI, program), tracking high-priority near-earth satellites, and tracking deep-space satellites (the Satellite Catalog Maintenance program) for the U.S. Space Command Space-track System (Fig. 3). KREMS, a supporter of the NASA Space Shuttle Program since the program's inception, also tracks shuttles and images payloads during deployment and subsequent orbit transfers.

The third support area, discrimination research, covers collection of data used to study BMD signature phenomena. In this capacity, KREMS plays a major role in the national BMD-discrimination research program by providing the scientific community with the capability to

test candidate waveforms, signal-processing concepts, and BMD algorithms. The U.S. BMD database consists primarily of KREMS data generated during the past 25 years.

The fourth support area includes support of BMD component and system tests. During the 1970s, KREMS collected and recorded data for the Safeguard system and System Technology Radar programs. More recently, the radar system collected and recorded data that characterized target vehicles, assessed interceptor miss distances, and analyzed postimpact debris for the Homing Overlay Experiments (HOE) and the Delta experiments of the Strategic Defense Initiative (SDI). For SDI, KREMS also provided real-time metric data to support a series of Surveil-



Fig. 2—Aerial view of the KREMS facility.

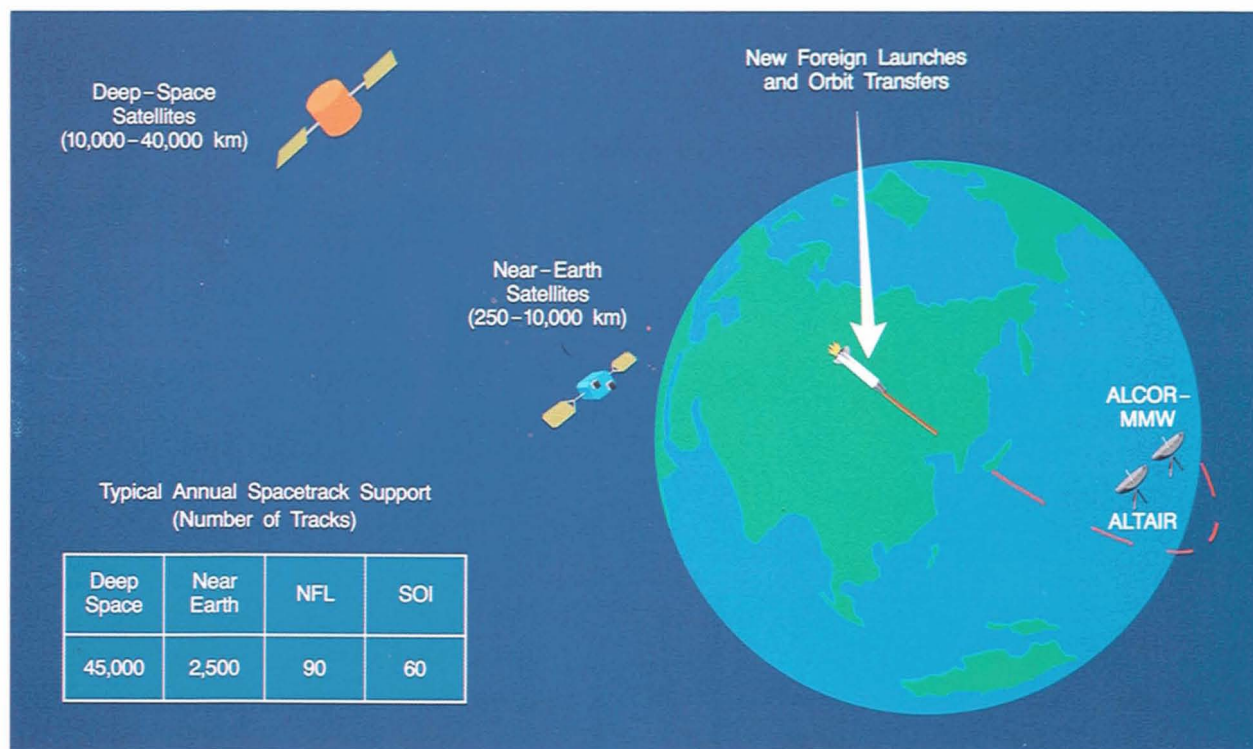

Fig. 3—KREMS's Spacetrack role.

lance, Acquisition, Track, and Kill Assessment (SATKA) Integrated Experiments (SIE). In the future, the evaluation of SDI component and system performance for the Exo-Reentry Intercept Subsystem (ERIS) and the High Endo-Defense Interceptor (HEDI) will require further support from KREMS. A more extensive discussion of KREMS's role for SDI is contained in Ref. 1.

The fifth and final support area falls under the broad category of scientific research. To support different users studying various natural phenomena, KREMS has performed extensive multifrequency sea-clutter backscatter measurements that help the Navy characterize and model the clutter environment. KREMS has also gathered ionospheric scintillation and electron-density profile data that help the Defense Nuclear Agency improve its ionospheric models. In addition, the radar system will assist NASA by gathering orbital-debris data not contained in the Spacetrack catalog, a listing of satellites currently orbiting the Earth.

KREMS

KREMS comprises a diverse collection of radars that cover a broad frequency spectrum, from VHF through W-band. Figure 4 shows the current operating bands of the four radars and Table 1 lists their basic parameters.

Except for MMW, all of the radars operate at peak power levels in the megawatt range. High transmit powers and large antenna apertures provide the system sensitivities necessary to produce the high signal-to-noise (SNR) data required to study radar signature phenomena. The radars also have large instantaneous bandwidths. MMW, with its 1,000-MHz bandwidth, achieves a resolution of approximately one-quarter of a meter. In addition to the features shown in Table 1, all of the four radars are coherent in that they provide both radar-cross-section (RCS) amplitude and phase data. The four radars also operate at dual polarization in which both the principal and orthogonal radar returns are received simultaneously.

A Brief History of KREMS

Thirty years ago, the Advanced Research Projects Agency (ARPA) of the Department of Defense needed a site for conducting research on ballistic-missile defense. ARPA (which has since been renamed DARPA) chose Kwajalein because of the atoll's geography and strategic location in the Pacific. Kwajalein, a member of the Republic of the Marshall Islands, is situated about 3,500 km southwest of Hawaii and encircles the world's largest lagoon. The size and location of the lagoon made it an ideal impact area for ICBMs launched from Vandenberg Air Force Base in California. To study the reentry physics of the ICBMs, ARPA selected Roi-Namur, the northernmost island of the atoll, as the site for a radar system. Thus Project PRESS (Pacific Range Electromagnetic Signature Studies), KREMS's original name, commenced and Lincoln Laboratory became the scientific director of the project. (At about the same time, the U.S. Army also chose Kwajalein as a downrange test site for Nike-Zeus, an antiballistic-missile project.)

In late 1959, ARPA selected RCA Corp. to install TRADEX, the first of Project PRESS's radars,

and TRADEX became operational at UHF and L-band in 1962. The first Laboratory personnel arrived on Kwajalein that year to provide technical supervision during the final checkout and acceptance of TRADEX. The second radar installed was ALTAIR, which became operational at VHF and UHF in 1969. ALTAIR was designed primarily so that the United States could see how its missiles appeared to Soviet radars. One year later, KREMS's third radar, ALCOR, became operational at C-band. ALCOR's goals were to investigate the applications of broadband data and to develop the technology necessary to generate and process 500-MHz bandwidth signals. In 1983, MMW became operational at 35 GHz, and MMS was added to TRADEX that year.

Table A shows how an intensive program of additions, modifications, and upgrades has kept KREMS at the forefront of technology.

In addition to the four major radars, various other sensors—including optical systems and an active laser radar—were built and adjunct experiments carried out over the years. Although some of the sensors have since been deac-

tivated, three of the adjunct systems listed in Table 1 remain operational today: ALTAIR Space Detection and Tracking System (SPADATS), currently referred to as Spacetrack; TRADEX MMS, which uses TRADEX as its illuminator and receiver as well as two remote receivers located on other islands in the atoll; and the Kwajalein Discrimination System (KDS), which is currently interfaced to the MMW radar. We discuss these three adjunct systems in greater detail in the main text.

KREMS is named after U.S. Army Lt. Col. Joseph M. Kiernan, who headed PRESS during the project's period of rapid growth from 1963 to 1966. Kiernan, an ARPA engineer, oversaw the addition of ALTAIR and ALCOR to the project. Kiernan later served as Commander of the 1st Engineer Battalion of the 1st Infantry Division in Vietnam, where he was killed in 1967.

A more extensive history of KREMS is contained in Ref. 1.

References

1. M.S. Holtcamp, *The History of the Kiernan Reentry Measurements Site* (Lincoln Laboratory, Lexington, MA, 1980).

The radars provide precise metric data. At a range of 250 km—which corresponds to the distance from Kwajalein at which many RVs first pierce the atmosphere—MMW and TRADEX's Multistatic Measurement System (MMS) adjunct are the most accurate. MMW and MMS provide position accuracy of about 10 m.

MMW's accuracy is due primarily to the radar's narrow beamwidth; MMS's accuracy results from the system's ability to make precise tri-static range measurements.

A complex reentry mission may cost more than \$100 million and take years to plan. The KREMS staff repeatedly rehearses for each mission

Table A. Chronology of Major KREMS Milestones

1959	KREMS (originally named Project PRESS) initiated. Roi-Namur site on Kwajalein Atoll selected.
1962	TRADEX operational at UHF and L-band.
1965	VHF capability added to TRADEX.
1969	ALTAIR operational at UHF and VHF.
1970	ALCOR operational at C-band.
1972	S-band capability added to TRADEX while UHF and VHF dropped. Reentry Designation and Discrimination Experiment commences.
1973	Simulate the Perimeter Acquisition Radar (SIMPBAR) Project and Solitaire Optical Experiment commences.
1974	Army Optical Station (AOS) established.
1976	Ground-Based Measurements (GBM) optical system established.
1977	Laser Infrared Tracking Experiment (LITE) and Pacific Barrier (PACBAR) trials commence.
1982	ALTAIR Space Detection and Tracking System (SPADATS) operational.
1983	MMW operational at 35 GHz. Multistatic Measurement System (MMS) operational.
1985	95-GHz capability added to MMW.
1987	Kwajalein Discrimination System (KDS) operational.

weeks ahead of time by using computer simulations. During these simulations (called nominals), the KREMS staff follows a time line: a script that orchestrates what each radar should be doing at each point during the mission. An actual mission takes only a half hour, from Vandenberg lift-off to Kwajalein splashdown, and a missile is within view and detectable by KREMS for just 15 minutes. During those 15 minutes, it is imperative that the KREMS radars perform their assigned tasks with precision to gather the appropriate data.

Figure 5 shows the network that connects the

radars with one another and with the KREMS Control Center (KCC), a central computer and control system that provides data fusion and centralized control of KREMS. The network consists of two fiber-optic Ethernets: one for transmitting target data and the other for exchanging display data. Data exchanged between the sensors include radar tracks (called target files), object identifications, RCS, waveform information, and information about each radar's mode of operation (e.g., if a radar is independently tracking a target, or if the radar is being directed by another radar). KCC and the KREMS

radars also exchange audio and video data over the network.

When it first receives data from the individual radars, KCC correlates and compares the data with *a priori* information, e.g., predicted or nominal trajectories and RCS static range measurements. Later in the mission, target files—which contain information about a target's position, velocity, and acceleration—from the various sensors are compared to validate the target identifications assigned by the sensors. In the event that two sensors compute different identifications of the same target or the same identification of different targets, KCC resolves the conflict with graphics displays that utilize the metric and RCS data from all the sensors.

To aid the sensors in acquiring, or locking onto, their assigned targets, KCC supplies each radar with the best available directing file by using a best-choice algorithm. To eliminate noise in the data, KCC smooths the trajectory

data in real time by using a least-squares fit algorithm. If necessary, KCC extrapolates the trajectory forward in time so that it can be used to direct the radars.

KCC provides all KREMS sensors with alphanumeric and color-graphics-display data. The data utilize target files from all of the KREMS radars as well as from other USAKA sensors—two MPS-36 radars and the FPQ-19 radar located elsewhere on the Kwajalein Atoll. With the data, KCC MASSCOMP graphics processors generate color displays, which are used by KCC console operators to monitor and direct a mission. Figure 6 shows the operator console for KCC.

During the tracking of an RV, KCC routes all of KREMS external communications to the USAKA Control Center on Kwajalein Island. To assist in acquiring targets, the KCC staff can transmit target file data via the USAKA Control Center to the MPS-36 and FPQ-19 radars, telemetry stations, optical sites, and other instru-

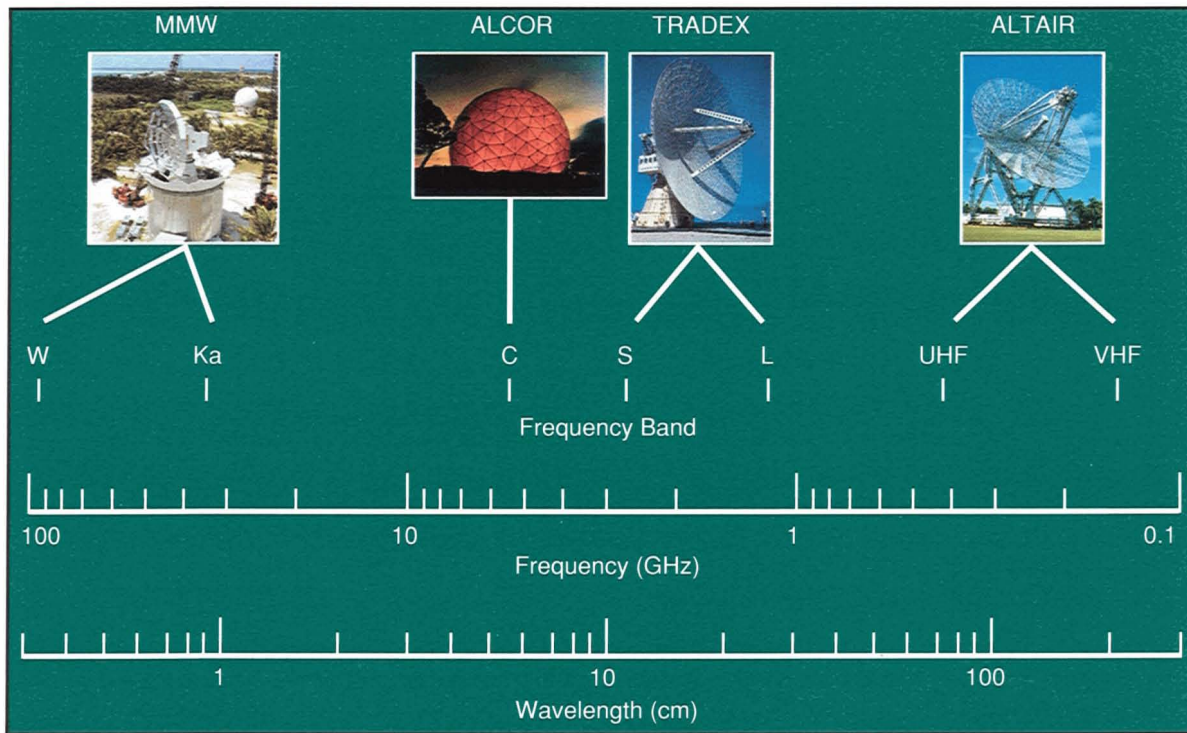

Fig. 4—Operating bands of the KREMS radars.

Table 1. KREMS Radar Parameters

	ALTAIR		TRADEX		ALCOR	MMW	
	VHF	UHF	L-Band	S-Band	C-Band	Ka-Band	W-Band
Center frequency (GHz)	0.162	0.422	1.32	2.95	5.67	35.0	95.5
Maximum bandwidth (MHz)	7	17.6	20	250*	512	1,000	1,000
6-dB range resolution (m)	37.5	15	15	1.0	0.50	0.28	0.28
Antenna diameter (m)	45.7	45.7	25.6	25.6	12.1	13.7	13.7
Beamwidth (mrad) (two-way beam width measured 6 dB from peak)	48.8	19.2	10.6	5.2	5.2	0.76	0.28
Antenna gain (dB)	34.7	42.4	48.2	54.2	55.0	70.1	77.3
Transmitter power (kW)							
Peak	7,000	5,000	2,000	2,000	3,000	25	5
Average	98	250	150	30	6	2.5	0.5
Pulse width (μ s)	0.25–600	0.1–1,000	2–565	3–9	10	50	50
Maximum PRF (PPS)	2,976	2,976	1,500	1,500	200	2,000	2,000
Single-hit SNR (dB) on 1.0 m ² target at 1,000 km range	36**	45**	40**	28**	23	17 [†]	-3 [†]

* equivalent bandwidth via frequency-jumped-burst (FJB) waveform

** using maximum pulse width

[†] 30° elevation, clear-air conditions

Antenna Descriptions

ALTAIR's antenna is a parabolic dish with VHF feed at its primary focal point and UHF feed that utilizes a Cassegrain focus via a frequency-selective subreflector (see Fig. 8, p. 258). As with all the KREMS radars, RC polarized energy is radiated and both LC and RC signals are received.

The TRADEX antenna is a five-horn, L-band, monopulse feed with a concentric S-band horn at the dish focal point. The antenna can be rotated 290° in azimuth and 180° in elevation.

ALCOR's antenna is a parabolic dish that uses a Dieguide feed with Cassegrain optics. A radome encloses ALCOR's antenna, pedestal, and support tower for protection from the highly corrosive Kwajalein environment.

The MMW antenna is a parabolic dish that uses Cassegrain optics with a vertex feed cluster made up of a 35-GHz four-horn monopulse assembly and a single 95-GHz horn. A radome encloses MMW's antenna, pedestal, and support tower for protection from the highly corrosive Kwajalein environment.

mentation situated within the Atoll. Conversely, target files from other USAKA radars can be transmitted through the USAKA Control Center to KCC for utilization by the KREMS radars.

Each radar is also capable of independent operation outside the KREMS network. For example, in its Spacetrack role ALTAIR operates autonomously for 128 hours a week via a dedicated link to the U.S. Space Command's Cheyenne Mountain Complex.

To keep pace with increasing mission complexity and to reduce dependence on operator expertise, KCC's level of automation is being increased. New color displays, operator alerts, and decision aids have been recently incorporated in the KCC display system and central

computers, both of which were replaced in 1988. KREMS will continue to evolve as additional target-identification algorithms are added to the system in the future.

The following sections contain descriptions of the individual KREMS radars.

ALTAIR

Initially, ALTAIR's duties were confined to research. The radar, which reached its 20th birthday on 19 April 1989, was constructed to give the United States a view of how U.S. ICBMs looked to Soviet radars. Subsequent modifications, however, transformed ALTAIR for tracking deep-space satellites and NFLs from the

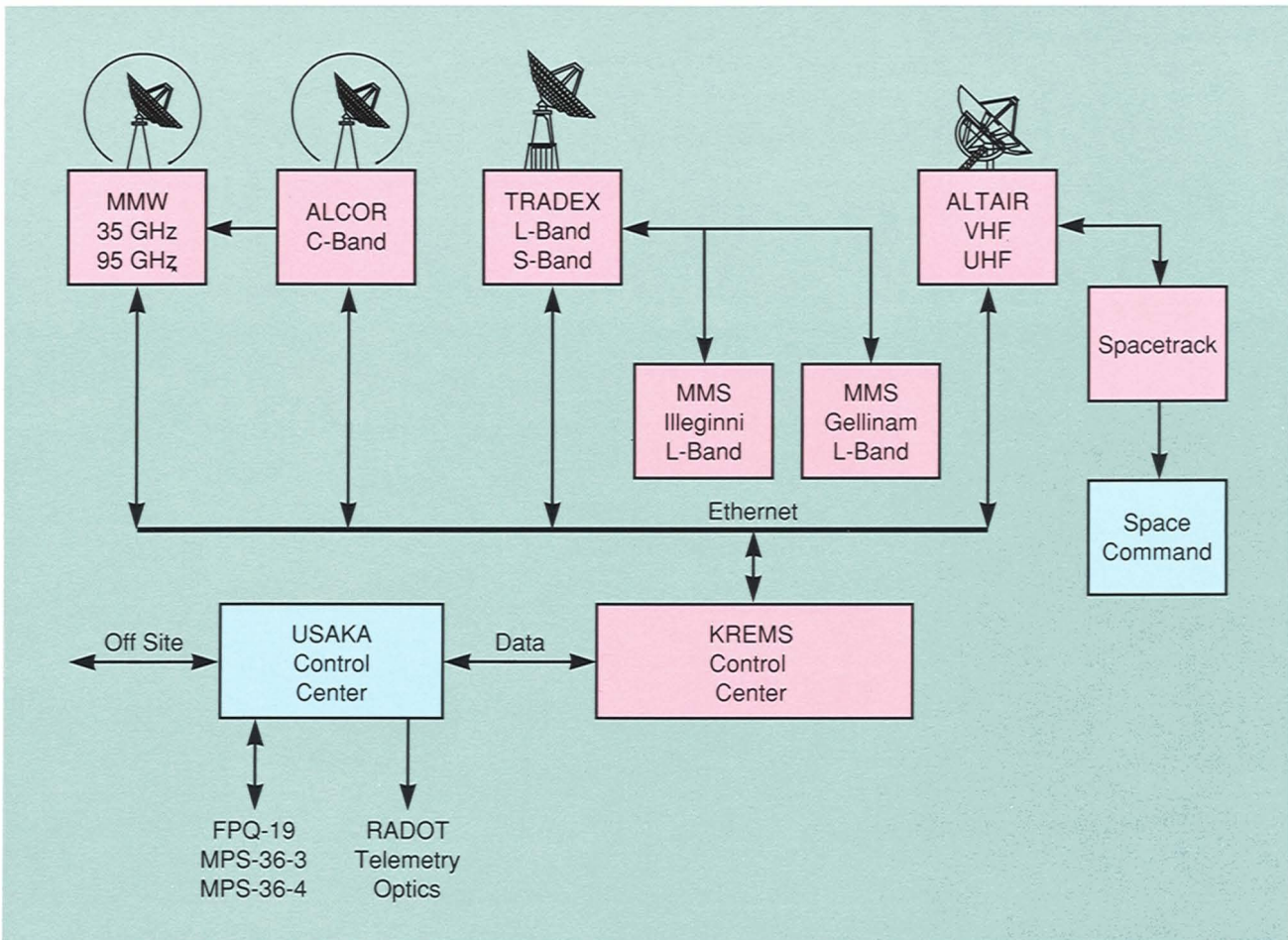

Fig. 5—The KREMS instrumentation network.



Fig. 6—The KREMS Control Center's operator console.

Soviet Union, China, and Japan. ALTAIR currently operates 24 hours a day. For 40 hours each week, the radar prepares for and supports missile reentries for USAKA. For the remaining 128 hours of the week, it tracks satellites for Space Command. NFL coverage is provided 24 hours a day, seven days a week.

Among the KREMS radars, ALTAIR has the greatest sensitivity. In November 1984, a traveling-wave-tube (TWT) transmitter replaced ALTAIR's original UHF Klystron transmitter. The present transmitter is an array of 24 TWTs combined through a series of hybrids. The resulting device has an output peak power of 5 MW and a duty cycle of 5%. ALTAIR's

VHF transmitter consists of two triode tubes with a combined output peak power of 7 MW and a duty cycle of 1.4%.

ALTAIR is able to view a reentry target shortly after it breaks the horizon, roughly at a distance of 4,500 km. The radar provides KREMS with its first view and assessment of a reentry-target complex, i.e., the number of objects and their spacing. ALTAIR keeps the range sidelobe levels for the metric waveforms at 40 dB or more below the mainlobe returns. Thus the radar can isolate and track a small target even when the target is in the vicinity of larger objects.

Figure 7 shows a photograph of the ALTAIR antenna, which has a diameter of 45.7 m and is

the largest of the KREMS radars. ALTAIR also has the widest beam width: 48.8 mrad in VHF and 19.2 mrad in UHF. ALTAIR's 880,000-lb antenna is supported by 16 wheels on a circular track with a diameter of 35.9 m. The antenna can be driven 90° in elevation and 380° in azimuth at rates up to 10°/s.

In addition to high sensitivity, one of ALTAIR's most important assets during RV tracking is the radar's dual-frequency capability. In 1973, modifications enabled ALTAIR to simulate the Perimeter Acquisition Radar (Project SIMPAR). At that time, a frequency-selective subreflector was added to allow the VHF feed structure to remain at the antenna's primary focal point, while a new UHF feed with tracking capability was installed at the Cassegrain focus (Fig. 8). Now simultaneous UHF and VHF target range measurements permit ALTAIR to adjust its ionospheric refraction model in real time. After a

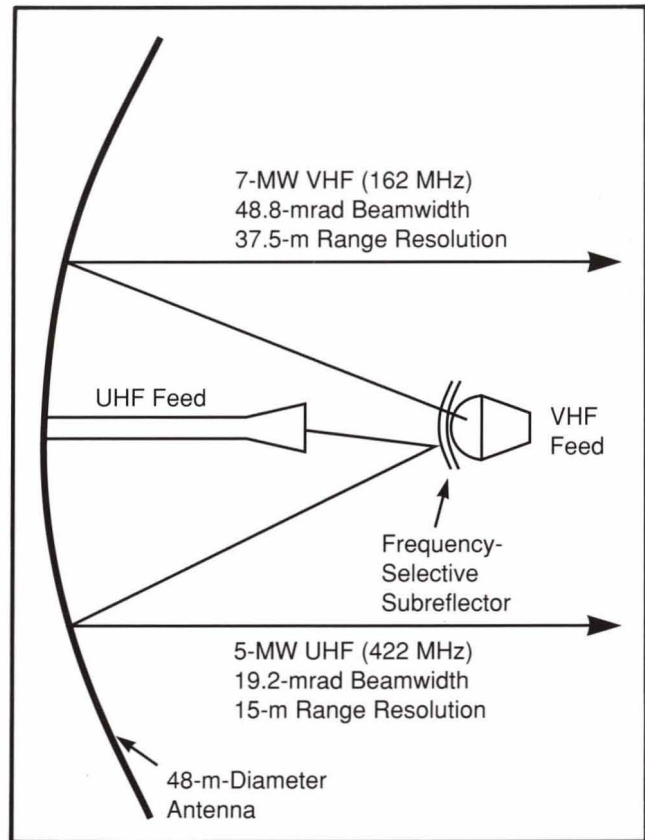

Fig. 8—The ALTAIR feed structure



Fig. 7—The ALTAIR antenna.

missile-reentry mission is completed, data analysts use these measurements to construct ionospheric models that correct not only the mission data from ALTAIR, but also that from TRADEX and ALCOR.

During recent years, ALTAIR has been in the throes of a massive computer upgrade, throughout which time the radar continues to operate 24 hours a day. Four VAX-11/785 computers, each with 16 MB of memory, were installed to support Spacetrack and reentry-mission software improvements. As part of the upgrade, many system enhancements were incorporated, including a replacement of the ALTAIR Recording System (ARS) with an all-digital system that uses high-speed parallel-transfer disks to gather amplitude and phase data based on premission-designed sample patterns around each target of interest. With the new system, an operator (Fig. 9) can lock onto and track up to 32 targets in the UHF and VHF beam.

The computer upgrade was completed in 1988; on 2 June 1988, ALTAIR conducted its first reentry mission with the new VAX system.

In addition to tracking U.S. missile reentries, ALTAIR took on the task of supporting the U.S. Space Command in October 1982. In this capacity, ALTAIR tracks near-earth-orbit and deep-space satellites. Space Command uses this information to update its catalog listings of current satellite positions. Via the Ethernet networks discussed earlier, ALTAIR provides ALCOR and MMW with pointing information so that the two radars can acquire, track, and image near-earth space objects in support of SOI.

The Kwajalein location enables ALTAIR to provide the United States with its first view of many Soviet and Chinese satellite launches. To track an NFL object, ALTAIR's staff needs an advance warning of less than 15 minutes. The radar has successfully handled more than 93% of the NFL events within its coverage (approximately 85 a year).

ALTAIR tracks more than 1,000 deep-space orbiting satellites every week, which accounts for approximately two-thirds of all radar tracks obtained by the U.S. Space Command. As a result of transmitter and software improvements, the figure of 1,000 satellite tracks a week is an increase of 300% from the radar's initial capability. The radar has logged more than 200,000 tracks to date from its first operational track on 1 October 1982.

ALTAIR Current and Planned Improvements

A capability to track satellites at synchronous-orbit ranges at VHF is being added to ALTAIR's present UHF deep-space tracking capability. While the initial efforts are aimed at tying VHF sample patterns to estimates of UHF range-tracker positions, it is expected that the planned addition of the Universal Signal Processor (USP) and other signal-processing upgrades will one day permit ALTAIR to track satellites independently at both UHF and VHF.

The all-digital USP, when installed in 1990,

will eliminate 18 racks of analog and digital compression and weighting filters, and greatly simplify the maintenance of ALTAIR's receivers. The USP takes a time-domain transversal-filter approach to the pulse compression and weighting of the four UHF and four VHF channels. Custom state-of-the-art CMOS chips are being designed and fabricated to perform the multiplication and accumulation functions of the transversal filters. The USP will operate with sampling rates up to 20 MHz to provide all-range pulse compression and weighting for all existing ALTAIR waveforms, which are described in Table 2(a) for VHF and Table 2(b) for UHF. Indeed, the USP will enable ALTAIR to process continuous wave (CW) and linear FM waveforms of any length and bandwidth up to a bandwidth limit of 20 MHz and a time-bandwidth-product limit of 2,400.

An ambitious program to upgrade ALTAIR's overall signal-processing capability is currently in the system study phase. The goal is to process the new USP digital outputs by using special hardware and modern array processors to provide automatic target acquisition and tracking for multiple-target complexes at both UHF and VHF. The same digital outputs would be used for ARS. Biases between ALTAIR's radar and recording system would therefore be eliminated; consequently, calibrating the separate



Fig. 9—The ALTAIR operator console

Table 2(a). ALTAIR VHF Waveforms

<i>Name</i>	<i>Duration (μs)</i>	<i>Bandwidth (MHz)</i>	<i>Maximum PRF (PPS)</i>	<i>Usage</i>
V600N	600	0.05	20	NFL search
V600W	600	0.25	20	NFL tracking
V238	238	0.345	60	Long-range tracking
V30C	30	CW*	372	Chaff tracking
V30	30	7	372	Exo-atmospheric tracking
V6	6	7	1,724	Reentry tracking
V.25C	0.25	CW*	2,976	Reentry tracking

* continuous wave

Table 2(b). ALTAIR UHF Waveforms

<i>Name</i>	<i>Duration (μs)</i>	<i>Bandwidth (MHz)</i>	<i>Maximum PRF (PPS)</i>	<i>Usage</i>
U1000	1,000	0.050	50	Deep-space search
U400	400	0.25	125	Deep-space tracking
U238	238	0.25	120	Long-range search
U120	120	18.0	372	Exo-atmospheric tracking
U15	15	17.6	372	Exo-atmospheric tracking
U3	3	17.6	1,724	Reentry tracking
U.1C	0.1	CW*	2,976	Reentry tracking

* continuous wave

A/D converters in the radar and ARS would be unnecessary.

A recent improvement to ALTAIR in the spring of 1989 was the replacement of the wheel and rail system with a new, longer-life design. To reduce the load on the wheels and rail that support the antenna, the number of wheels was increased from eight to 16. This upgrade should extend the life of the rolling system by an additional 25 years.

TRADEX

A large repertoire of waveforms is TRADEX's greatest asset. The radar is capable of using chirp pulse waveforms to track an RV during reentry while interleaving other waveforms—e.g., bursts and pulse pairs—to gather high-resolution Doppler data on the low-velocity, high-electron-density wake that forms behind the vehicle. Like ALTAIR, TRADEX tracks ICBM launches from Vandenberg and simulates Soviet radars tracking U.S. RVs. TRADEX also acts as ALTAIR's backup for tracking NFLs and deep-space satellites.

Figure 10 shows a photograph of the TRADEX antenna: a 25.6-m parabolic dish with a dual L/S-band feedhorn at the focal point. TRADEX has a unique combination of two capabilities: long-range (45,000 km) L-band tracking of satellites, and collection of high-resolution (1 m) S-band signature data at shorter range. For its size, TRADEX's antenna is highly maneuverable; it can be rotated 290° in azimuth and 180° in elevation. Measured axial ratios of the antenna's circular-polarization sum-mode ports are less than 0.5 dB at both L- and S-bands. Because of the small axial ratios, TRADEX provides excellent polarimetric signatures—key features for identifying targets.

TRADEX can range-track a single target in either L-band or S-band; angle tracking is performed at L-band only. Right-circular (RC) polarization is radiated at each frequency and right-and-left-circular (RC/LC) polarizations are simultaneously received. Alternatively, dual-linear polarization may be selected for S-band on a mission-by-mission basis. An array

processor coherently integrates the L-band LC range and angle channels to provide up to 30 dB of additional system sensitivity in real time.

TRADEX, the oldest of the KREMS radars, has less sensitivity but better resolution than ALTAIR (Table 1). TRADEX can lock onto and track synchronous-orbit satellites at ranges up to 45,000 km and RVs at ranges approaching 4,000 km. Targets are tracked with either a ballistic filter or a polynomial filter with fixed or variable weighting. The radar achieves S-band range resolution of 1 m by using a frequency-jumped-burst (FJB) waveform (with 60-MHz-bandwidth subpulses) that covers a total bandwidth of 250 MHz. Currently, this waveform can only be compressed offline. The highest available real-time range resolution is 5 m.

Tables 3(a) and 3(b) summarize respectively the characteristics and usage of the current TRADEX L-band and S-band waveforms. The single-pulse or train waveforms may be run continuously. In contrast, the burst waveforms—L2B, S9B, S3B, and SFJB—have maximum numbers of pulses and maximum burst-repetition frequencies that are determined by the transmitter's average power limits. The variable subpulse spacing for the burst and pulse-pair waveforms ranges from 4 μ s to 512 μ s.

Multiplexing of up to three L-band and three S-band waveforms is possible within each 0.1-s basic operating interval. Trains and bursts may be freely mixed with nonrepeating patterns up to 3 s long. However, certain constraints apply. For example, there must be at least one track waveform per interval and each L-band burst must be accompanied by an S-band burst.

TRADEX was built to study reentry phenomenology. The radar became operational at UHF and L-band in 1962; since then, it has undergone many modifications. The three most significant were the replacement of UHF with S-band in 1972, the addition of the MMS adjunct in 1983, and the implementation of coherent integration in 1986.

Figure 11 shows the configuration of the MMS subsystem. In MMS, the TRADEX antenna is the target illuminator. Range measurements are received and recorded by the TRADEX radar as



Fig. 10—The TRADEX antenna.

well as by two remote L-band receivers located on the Kwajalein islands of Gellinam and Illeginni, which are about 40 km from Roi-Namur. Since range can be measured more accurately than other target-position parameters, MMS's tristic measurements of RV positions at atmospheric pierce point is the most accurate obtained by the KREMS radars. MMS also provides bistatic L-band signature data.

The MMS L-band tristic system operates as an adjunct to the TRADEX radar. It has approximately 14 dB less sensitivity than TRADEX but is sensitive enough to measure RV dynamics near atmospheric pierce point. Table 4 shows the key performance parameters for MMS.

The TRADEX system performs a wide variety of tracking and measurement missions. Most of the missions are to track ICBM launches from Vandenberg and payloads deployed by local missile launches from Kwajalein Atoll. To develop and study reentry discrimination algorithms and reentry physics phenomena, the BMD community has extensively used TRADEX's database of burst and pulse-pair

waveform data. In addition, by incorporating and gathering data with specially configured waveforms, TRADEX can simulate how U.S. RVs look when they are tracked by Soviet radars.

Because its antenna is 26.2 m above sea level, TRADEX has an excellent view of the ocean horizon. Consequently, the scientific community has used the radar to collect extensive sea-clutter measurements and surface-ship signature data.

Other miscellaneous applications include passive reception of signals from remote radio stars via a special X-band receiver that was temporarily installed near the antenna's L/S feedhorn. The data, which are correlated with those received by sensors in other parts of the world, help determine the motion of the Earth's crustal plates.

TRADEX Current and Planned Improvements

TRADEX is undergoing a host of modifications and upgrades. The most significant upgrade under way is the replacement of the radar's computer and timing system.

Two Gould 32/9780 computers are replacing TRADEX's 1970-vintage Sigma 5/Telefile-85 machine because the current CPU has reached its capacity. The Gould computers will increase the system's computing power by more than four times. Furthermore, the new computers will add, among other capabilities, a 3,000-Hz pulse repetition frequency (PRF) and simultaneous L/S-band tracking. The Gould computers operate via a reflective memory system in which the machines share a common database.

TRADEX's present timing and control system, installed in 1972, is also being replaced with a modern programmable system. The new system enables the testing of TRADEX through the use of two software test targets whose individual ranges and velocities can be varied. Scheduled for completion by October 1990, the new system will also enable more flexible system troubleshooting.

In preparation for SDI experiments, a multi-target tracker (MTT) is being developed for

Table 3(a). TRADEX L-Band Waveforms

Name	Duration (μ s)	Bandwidth (MHz)	Maximum PRF (PPS)	Usage
L565W	565	1.6	187	Extended-range tracking
L50N	50	1.0	1,500	Long-range acquisition, chaff tracking
L50W	50	20.0	1,500	Exo-atmospheric tracking
L2	2	20.0	1,500	Reentry tracking
L2B (burst)	28–896*	20.0	100**	Reentry signature

* 2- μ s subpulse with variable subpulse spacing
 ** bursts/s with variable subpulse spacing

Table 3(b). TRADEX S-Band Waveforms

Name	Duration (μ s)	Bandwidth (MHz)	Maximum PRF (PPS)	Usage
S9	9	17.6	1,500	Exo-atmospheric tracking
S3	3	60	1,500	Reentry tracking
SPP (pulse pair)	14–512	17.6	750*	Reentry signature
S3B (burst)	8–800	60	100*	Reentry signature
SFJB (FJB)	8–800	250	100*	Reentry signature
S9B	28–800	17.6	100*	Reentry signature

* bursts or pairs per second

Note: All bursts and pulse pairs have variable subpulse spacing. SPP, S3B, and SFJB use 3- μ s subpulses. S9B uses 9- μ s subpulses.

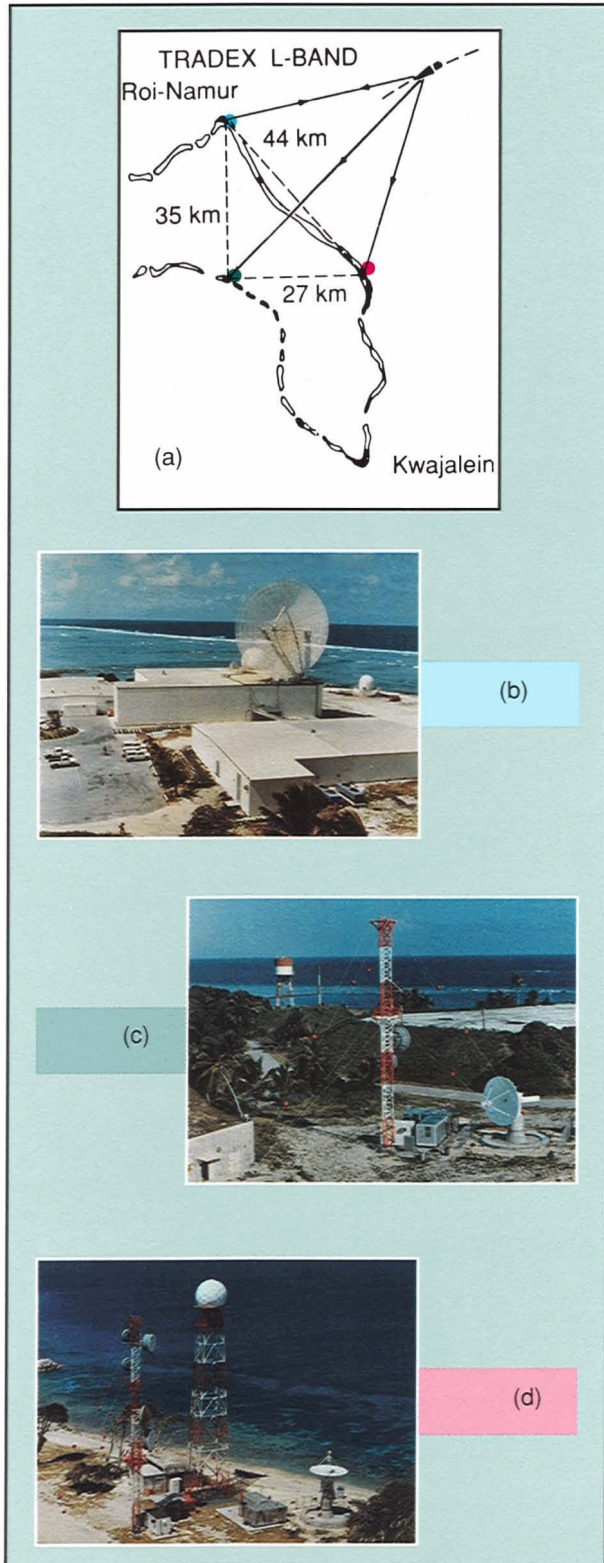

Fig. 11—(a) Map of MMS. (b) TRADEX site. (c) Illeginni site. (d) Gellinam site.

Table 4. MMS Performance Parameters

Remote-Site Sensitivity:	SNR = 19 dB on -25-dBsm target at 200-km range
Received Waveforms:	50 μ s/20-MHz chirp (L50W) 2 μ s/20-MHz chirp (L2) 2 μ s/20-MHz burst (L2B)
Range Resolution:	15 m
Metric Accuracy (RV at pierce point):	12-m position accuracy 0.1-m/s velocity-vector accuracy 0.2-g acceleration-vector accuracy

TRADEX. The MTT will enable the radar to perform simultaneous range/angle tracking of multiple targets in the L-band beam. The MTT will noncoherently integrate the received pulses, then automatically detect, track, and collect signature data on as many as 64 targets. A maximum of 12 target tracks may be sent to KCC over the sensor Ethernet.

Two new L-band waveforms, scheduled to be operational in 1990, will improve TRADEX's ability to perform complex evaluation on reentry missions and to back up ALTAIR for Spacetrack operations. A digital pulse-compression system is being developed for two new 565- μ s L-band waveforms, which will have 50-kHz and 150-kHz bandwidths. These waveforms will be used for long-range acquisition and will provide a coherently integrated range window of up to 250 km on the array-processor display. The maximum extent of the range window of TRADEX's current array processor is 4.8 km. The larger window will enable TRADEX to search for and lock onto satellites that are up to 125 km off their nominal trajectories, and perform RV-complex evaluation at horizon break. The addition of

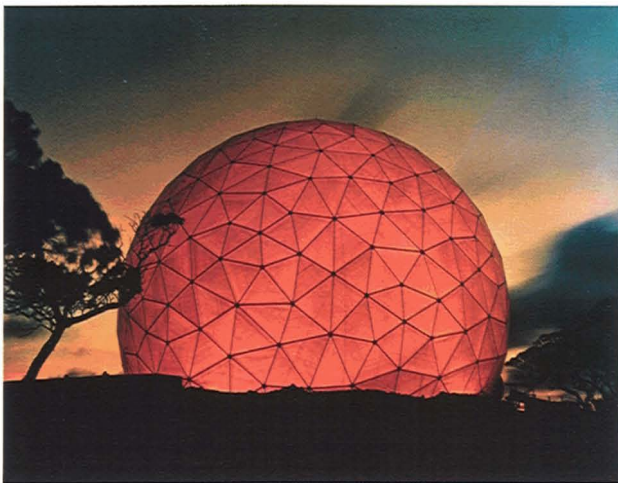

Fig. 12—Photographs of the ALCOR antenna. (a) Interior antenna. (b) Exterior radome.

noncoherent post-summing, which is almost operational, will improve TRADEX's ability to track satellites exhibiting large Doppler spread. Furthermore, new acquisition and tracking algorithms are also being developed. When all of these improvements are completed, TRADEX

will possess almost the same near-earth and deep-space acquisition and tracking capabilities as ALTAIR.

A new S-band chirp waveform should be operational in 1990. This 94- μ s S-band waveform will increase TRADEX's current S-band sensitivity by 10 dB, which will enhance the radar's measurements of S-band target signatures.

In summary, the TRADEX and MMS systems are continuing to evolve toward better measurement capability, improved reliability, and easier maintainability.

ALCOR

ALCOR became operational in 1970 as one of the first radars in the world to utilize wideband transmissions. ALCOR's wide bandwidth and narrow-beam antenna (Fig. 12) enable the radar to measure trajectories more precisely than any of the other KREMS sensors except MMW. Because of its high range resolution, ALCOR can observe the individual scattering centers on objects. During missions, this capability operates in real time to observe the length of objects within a target complex (Fig. 13). The length measurements are used to identify objects of interest and to discard unwanted ones. The high-resolution data are also used postmission to study RV and wake-scattering behavior.

In addition, ALCOR's coherent high-resolution measurements can be used to generate two-dimensional images of orbiting and reentering objects. The radar routinely images about 60 satellites per year in support of the SOI activities of the U.S. Space Command. Images are generated, sometimes on short notice, and are rapidly relayed to Space Command's Cheyenne Mountain Complex via an encrypted electronic link. ALCOR images have been used to determine satellites' size, shape, configuration, and stability/orientation, and to assess potential damage.

RVs often carry beacons to assist radars in locating and identifying the targets. ALCOR is the only KREMS radar capable of tracking a beacon; consequently, it frequently directs the other KREMS radars to their assigned targets. ALCOR can track beacon-carrying targets from

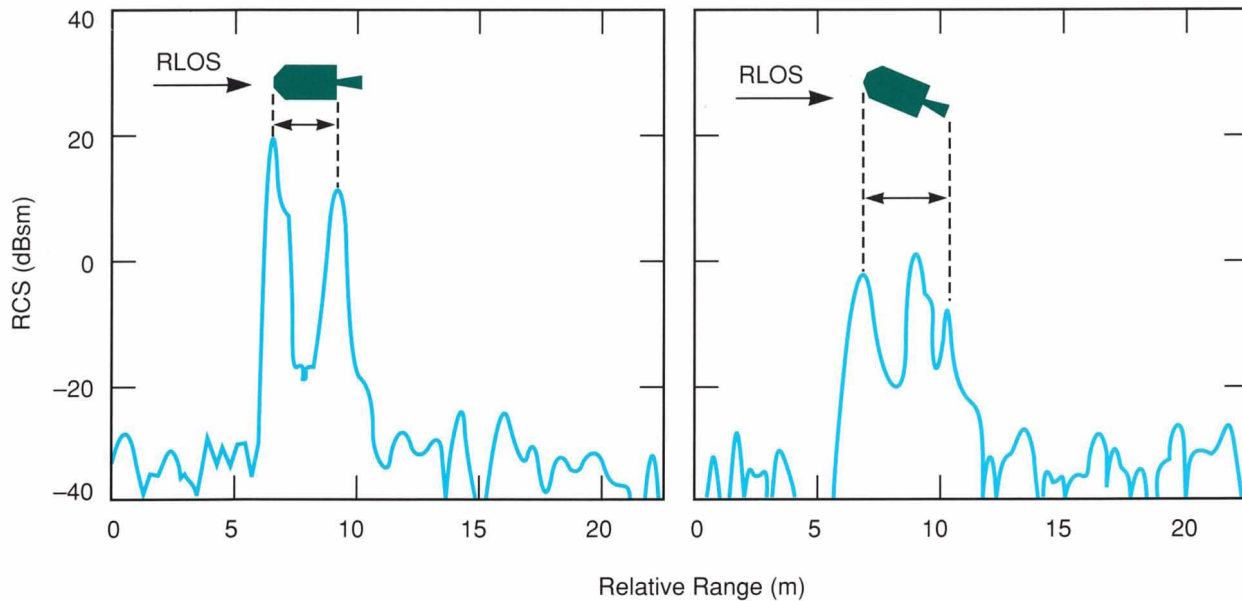

Fig. 13—ALCOR's wideband pulse returns for different target orientations.

the point at which they break the horizon, typically about 4,000 km away. The radar can easily identify beacon-carrying RVs in the presence of deployment junk (hardware used to eject a vehicle) and other objects.

Prior to a mission lift-off, ALCOR generates weather scans to observe the local meteorological conditions. The radar's narrow beam and favorable C-band frequency are valuable for generating both azimuth and elevation weather scans (Fig. 14). These weather scans are part of the database used in deciding whether or not to launch the missile. ALCOR usually makes trajectory scans immediately following an object's reentry in order to measure the weather that the object actually encountered.

The ALCOR transmitter—a three-stage amplifier—is unique in its degree of signal phase and amplitude control over its full 512-MHz bandwidth. This control was necessary to obtain low time-sidelobe response. The final high-power stage of the transmitter is a Twystron tube.

The ALCOR waveform parameters are described in Table 5. Four channels of return signal (sum-channel-principal and sum-channel-orthogonal polarizations, and two difference channels) are amplified by uncooled

parametric amplifiers and down-converted to 60-MHz IF. Delay lines at IF serially multiplex the receiver channels to a single A/D device. After conversion, the digital data are stored on magnetic disks and later transferred to magnetic tapes for transmission to Lincoln Laboratory.

With its range resolution of 0.5 m, ALCOR could record an immense quantity of data. To restrict the quantity to tractable portions, the range interval over which ALCOR records wideband data is limited to a maximum of three 30-m windows. This limitation permits stretch processing, a time-bandwidth exchange technique, which greatly reduces a recorded signal's bandwidth. The processing is performed by mixing the received signal, which is linearly chirped over 512 MHz, with a reference ramp of the same chirp (Fig. 15). The correlation mixer produces a steady tone at a frequency determined by the time offset between the chirped target return and the trigger time of the reference ramp. The correlation process thus translates differences in target range into differences in frequency. The target location is determined by spectral analysis of the correlation mixer's output. With stretch processing, ALCOR's

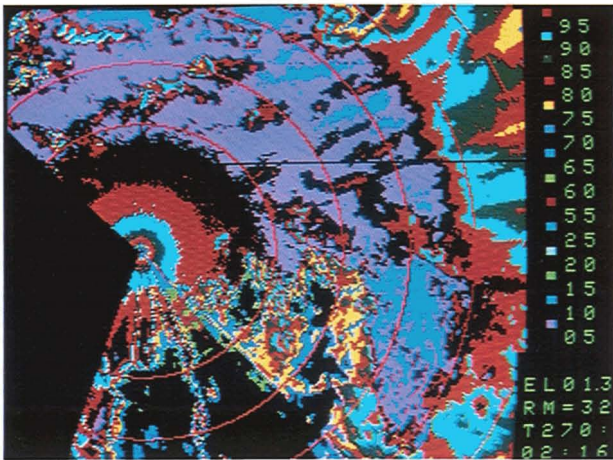
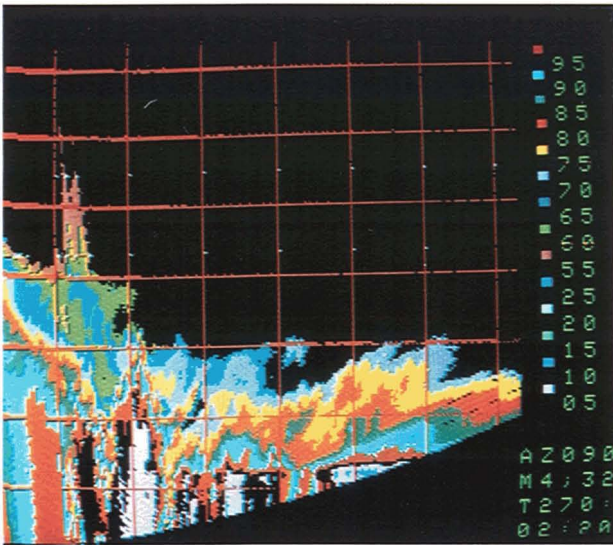

Fig. 14—Weather scans generated by ALCOR. (a) Range-height intensity plot. (b) Plan-position intensity plot.

10-MHz A/D device is capable of processing the 512-MHz chirped pulses and achieving 0.5-m range resolution after weighting.

ALCOR Current and Planned Improvements

A major upgrade of ALCOR's computer system is under way. The system is currently operating with its original equipment; it includes two Honeywell DDP-224 CPUs with a total of 48 kilowords of memory. The memory and compu-

tational speed limitations of the Honeywell computers, which are over 20 years old, have severely restricted ALCOR's growth during the past decade. Consequently, a Gould 32/9780 CPU with 16 MB of memory is replacing the DDP-224 system. Installation of the Gould computer began in December 1988, and the computer's system software, which is being developed at Lincoln Laboratory, will be operational in October 1990.

In addition, the ALCOR timing system is being modified to link the radar to the Kwajalein Discrimination System (KDS). The link will enable KDS to perform real-time processing of data from ALCOR as well as from MMW in order to generate images and to apply candidate discrimination algorithms to reentry objects. (A description of KDS is contained in the following section and in Ref. 2.)

After the basic computer upgrade is completed, additional improvements will commence. Future plans call for doubling ALCOR's pulse rate from 200 Hz to 400 Hz. The increase, when combined with the addition of real-time integration, will improve the radar's range capability. Multitarget sampling will allow simultaneous data gathering on multiple objects within ALCOR's beam. By the early 1990s the multitarget capability will support users' plans to fly target complexes that contain several closely spaced objects.

In summary, ALCOR is a valuable component of KREMS. It provides all-weather precision tracking and imaging capability; it is the most favorable KREMS radar for weather measurements; and it is the only KREMS radar with the ability to track beacon-carrying objects. The new computer will provide the potential for greatly expanding the radar's capabilities in the future.

MMW

MMW is a high-power, wideband, coherent radar that operates in the Ka- and W-bands. It is unique in its very narrow beamwidth (760 μ rad at 35 GHz and 280 μ rad at 95 GHz) and 1-GHz bandwidth (Table 1). Consequently,

Table 5. ALCOR C-Band Waveforms

<i>Name</i>	<i>Duration</i> (μ s)	<i>Bandwidth</i> (MHz)	<i>Maximum PRF</i> (PPS)	<i>Usage</i>
Narrowband (NB)	10.2	6	203	Acquisition and tracking
Wideband (WB)	10.0	512	203	Satellite imaging Reentry tracking Reentry signature
Wideband doublet (WBDBLT)	10.0*	512	100	Reentry signature
Beacon (BCN)	0.4	4.4 (CW)	203	Beacon tracking

* Pulse pair: two pulses of 10.0- μ s duration each; second pulse delayed 10.5 μ s behind first

MMW has the best range resolution—approximately 0.25 m after weighting—of the KREMS radars.

MMW was initially designed as an augmentation to the C-band ALCOR. The radar's original charter was to provide a database of millimeter-wave signature data of reentry phenomena and to support miss-distance measurements for interceptor experiments. MMW, however, has since grown to become a complete and self-sufficient system. Currently, the radar is related to ALCOR only in that they share a single console room.

With its 1-GHz bandwidth, MMW collects data for generating images of orbiting and reentering objects. Because of its high range resolution and short wavelength, MMW provides sharper images than ALCOR. MMW collects signature data at both 35 GHz and 95 GHz and performs monopulse angle tracking at 35 GHz.

Principal applications of MMW include (1) precision tracking, (2) high-resolution RV and wake measurements, (3) RV and satellite imaging, (4) miss-distance measurements, and (5) real-time discrimination. The first three applications are similar to the applications noted earlier for ALCOR. MMW's higher bandwidth

and narrower beam, however, provide finer-scale measurements.

Because of its ultrahigh range and angle resolution, MMW can accurately measure the miss distances of intercepting objects, as well as maintain track of selected targets in cluttered environments. During missions in which objects of interest pass through the debris of a disintegrating PBV, MMW is frequently the only KREMS radar with enough resolution to maintain track of the objects.

The coherent, high-resolution data that MMW records provides excellent images of satellites. Since February 1988, satellite images have been transmitted directly to Cheyenne Mountain. With this new capability, MMW now provides near-real-time SOI support to Space Command.

Real-time imaging of RVs became possible in the fall of 1987 with the initial operation of KDS, which the BMD community is using as a testing ground for discrimination algorithms. Figure 16 contains a block diagram of KDS and its interface to MMW. Currently, KDS is noninvasive in that the system taps off MMW's 60-MHz IF radar returns in parallel and then independently processes (e.g., digitizes and pulse-compresses) the returns. RV images are generated at a rate of

60/s. The data are then provided to a set of candidate discrimination algorithms. In addition to RV imaging, the feasibility of generating satellite images in real time was demonstrated with

KDS in the spring of 1989.

Technologically, the MMW system embodies a number of novel approaches. The transmitted waveforms, which are described in Table 6,

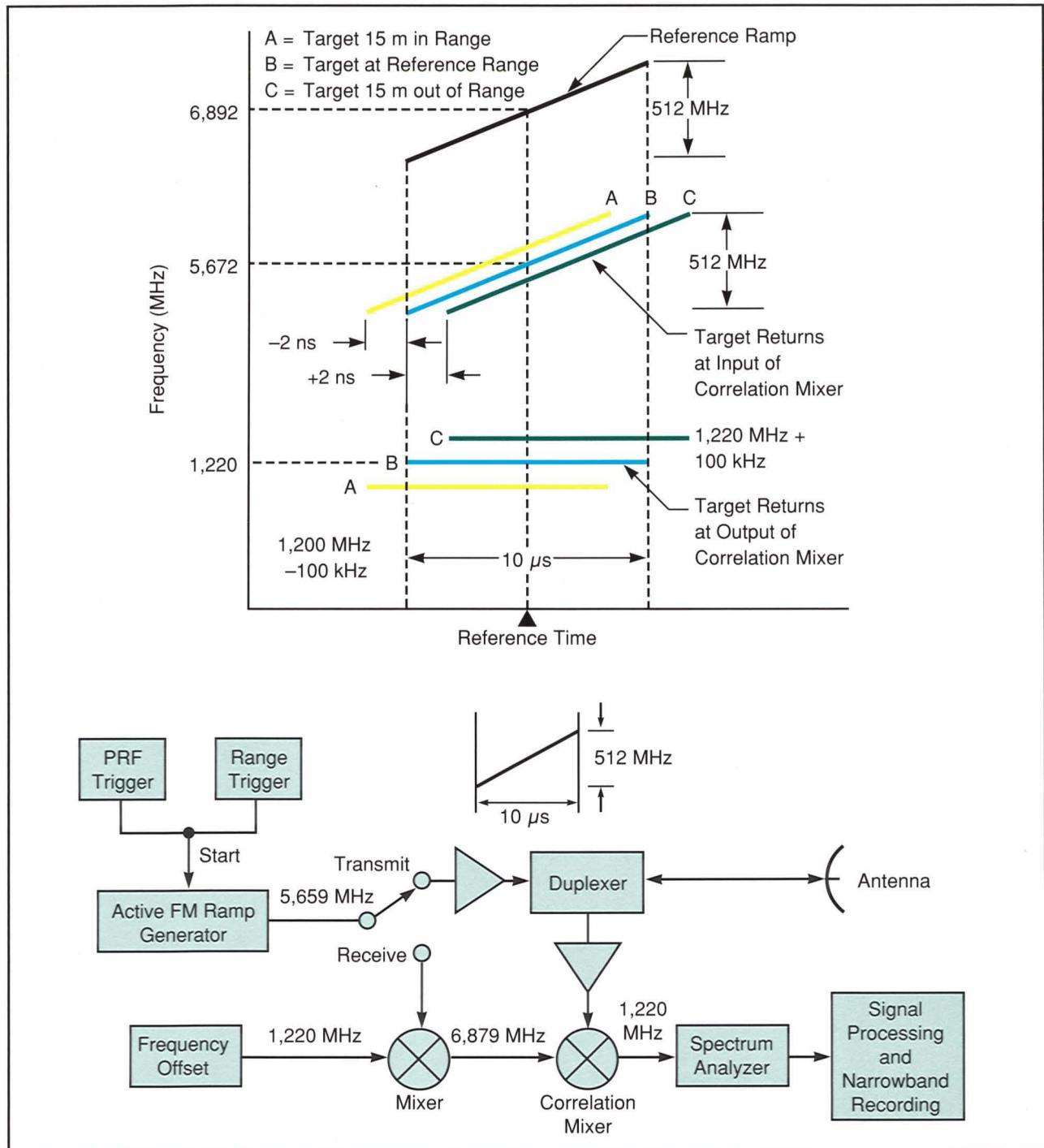

Fig. 15—ALCOR's time-bandwidth exchange.

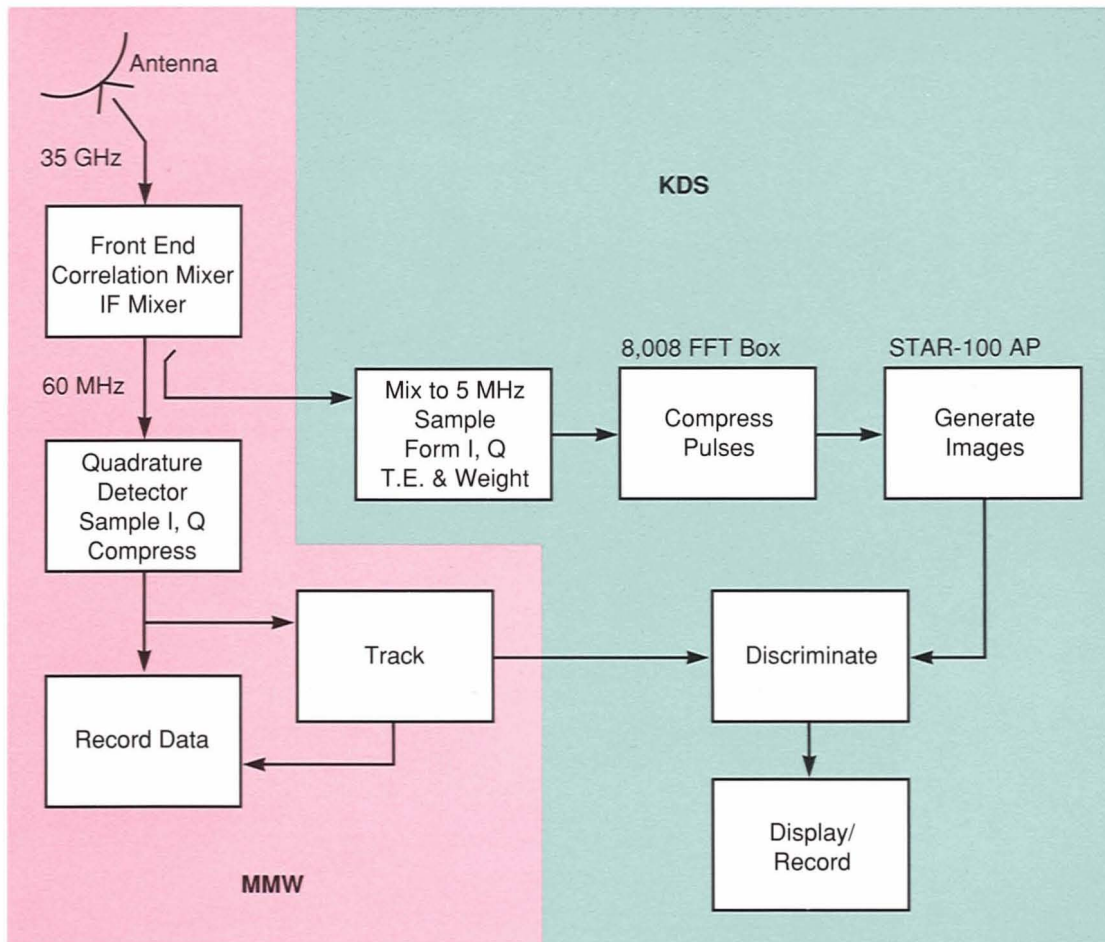

Fig. 16—Simplified block diagram of the Kwajalein Discrimination System (KDS) and the system's interface to MMW.

consist of linear FM pulses of 50- μ s durations in which the bandwidths and frequencies can be selected on a pulse-by-pulse basis. Four bandwidths are available: 6 MHz, 12 MHz, 500 MHz, and 1,000 MHz. MMW uses two independent TWT transmitters of similar design, one for each frequency band. The TWTs, which Varian Associates designed and built, were the first practical application of a TWT to a millimeter-wavelength field radar.

MMW's extremely wide linear FM bandwidth of 1 GHz presents a problem to conventional (i.e., dispersive delay line) approaches to pulse compression. Not only is the RF bandwidth near the limit of (if not beyond) the capabilities of current surface-acoustic-wave technology, but the

compressed signal bandwidth is beyond the state of the art in A/D technology. These problems are circumvented with the same time-bandwidth exchange technique used by ALCOR. The output of the correlation processor is digitized and recorded at 5 MHz on magnetic disks. A portion of the digitized returns are processed by an array processor that performs the functions of pulse compression and weighting, target-range marking, coherent integration, and monopulse error computation.

The MMW antenna is a 13.7-m-diameter precision parabolic dish (Fig. 17) that uses Cassegrain optics with a vertex feed cluster made up of a 35-GHz four-horn monopulse assembly and a single 95-GHz horn. The an-

tenna's surface is precisely aligned and has yielded a measured gain of 77.3 dB at 95 GHz. Special attention was given to the mechanical stiffness and the thermal properties of the materials used to fabricate the structure. To minimize thermally induced structural deformations, the antenna system uses a radome with an environmental control system that maintains thermal gradients within 3°F across the antenna. The reflector surface is smooth to 0.1-mm rms; the antenna is aligned to precise tolerance and yields a beam-pointing accuracy of 65 μ rad.

A MODCOMP 32/85L computer, with two CPUs in a load-sharing configuration and a single 6-MB random-access memory chassis, maintains real-time control of the system.

MMW Current and Planned Improvements

In the fall of 1988, the installation of two software improvements doubled the operational range of MMW at 35 GHz. The improvements were (1) noncoherent integration in range-Doppler space prior to display at the range operator's console, and (2) replacement of the Helms track filter with a Kalman ballistic filter. These improvements were first demonstrated during a mission in October 1988. The upgrades have not only improved performance during reentry missions, but also enhanced the radar's utility for SOI applications.

Three other major improvements to MMW's 35-GHz system are currently in progress (Fig.

Table 6. MMW Ka- and W-Band Waveforms

<i>Name (Frequency)</i>	<i>Duration (μs)</i>	<i>Bandwidth (MHz)</i>	<i>Maximum PRF (PPS)</i>	<i>Usage</i>
3N1 (35 GHz)	50	6	2,000	Acquisition and tracking
9N1 (95 GHz)	50	6	2,000	Acquisition and tracking
3N2 (35 GHz)	50	12	2,000	Acquisition and tracking
9N2 (95 GHz)	50	12	2,000	Acquisition and tracking
3W1 (35 GHz)	50	500	2,000	Satellite imaging Reentry tracking Reentry signature
9W1 (95 GHz)	50	500	2,000	Satellite imaging Reentry tracking Reentry signature
3W2 (35 GHz)	50	1,000	2,000	Satellite imaging Reentry tracking Reentry signature
9W2 (95 GHz)	50	1,000	2,000	Satellite imaging Reentry tracking Reentry signature

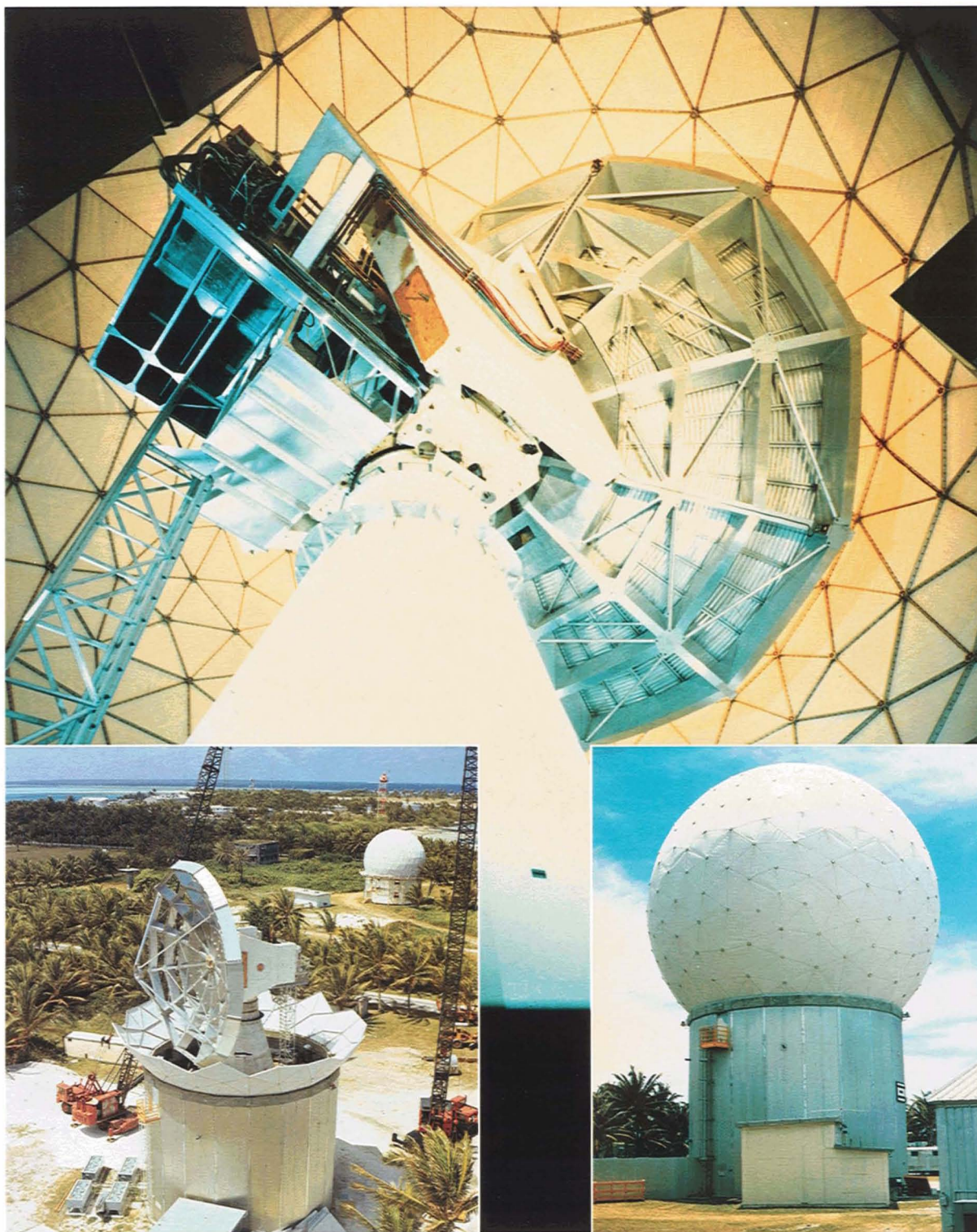

Fig. 17—MMW antenna.

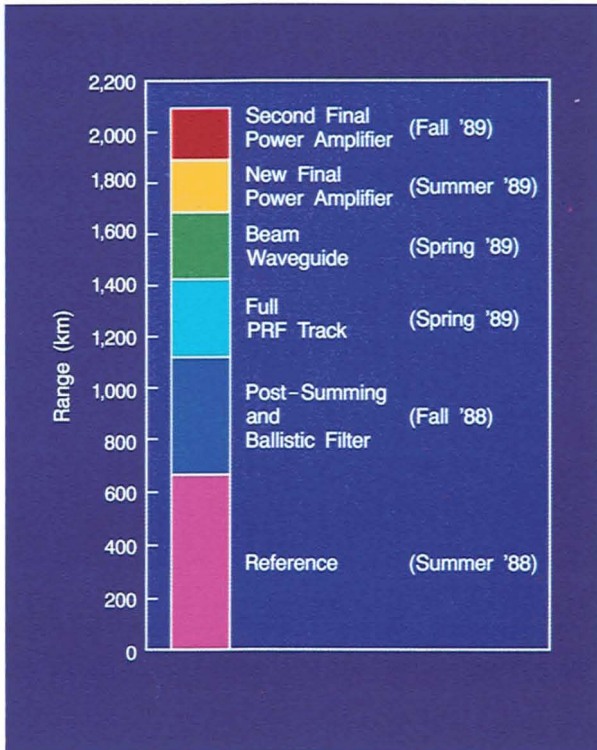

Fig. 18—RV-tracking performance improvements for MMW at 35 GHz for a typical reentry mission.

18). When completed, the improvements will increase the radar's sensitivity by 12 dB, which will again double the radar's operational range.

The first of the three upgrades will enable real-time processing of all transmitted pulses, up to the full system PRF of 2,000 Hz, by utilizing the KDS pulse-compression system. (In the past, only a fraction of the pulses could be compressed in real time.) This improvement will provide up to a 5-dB increase in sensitivity during coherent track mode and a 10-dB increase in noncoherent track mode.

The second of the upgrades is the replacement of conventional rigid-waveguide components, which are used to transport RF energy from the output tube to the antenna feed. The guides will be replaced with a quasi-optical-transmission system, referred to as beam waveguide (BWG). In a rigid-waveguide system, high-loss and limited-power handling capability is a severe limitation to radar sensitivity. The BWG system

(Fig. 19) uses mirrors to transport RF energy from the feedhorn (which is located close to the power output tube) to the antenna feed. By using free-space transmission, the BWG system reduces losses by 4 dB when operating in 35-GHz mode. In addition, the BWG system can carry much higher power levels than the conventional waveguide system. Although initially just the 35-GHz system is being converted, the 95-GHz system will also be modified in the future. The planned modification will reduce by approximately 20 dB the huge waveguide losses that currently occur at 95 GHz.

The third and final upgrade, which the BWG conversion will make possible, is the replacement of the original 25-kW final-stage TWT amplifier with a new 60-kW tube built by Varian Associates. In addition, another such tube is being added and the two Varian tubes will operate in parallel. The two-tube system

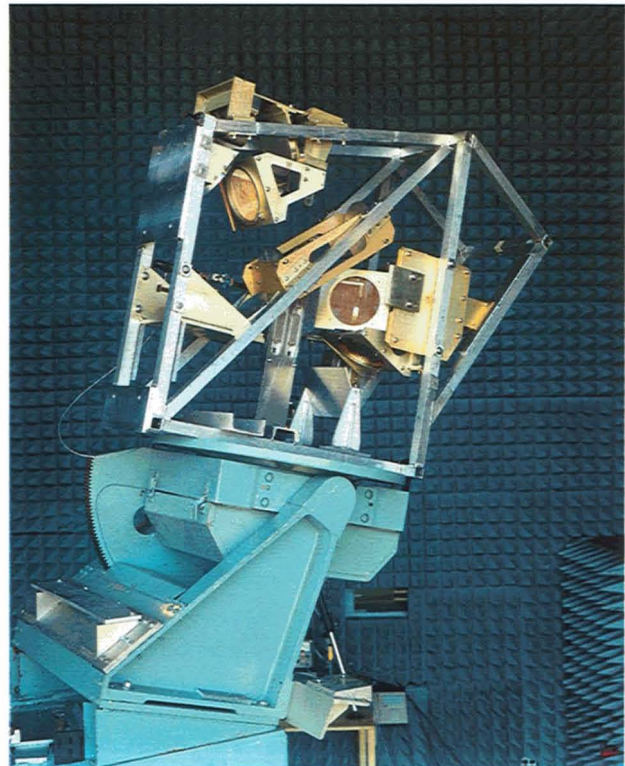

Fig. 19—The MMW beam-waveguide (BWG) system.

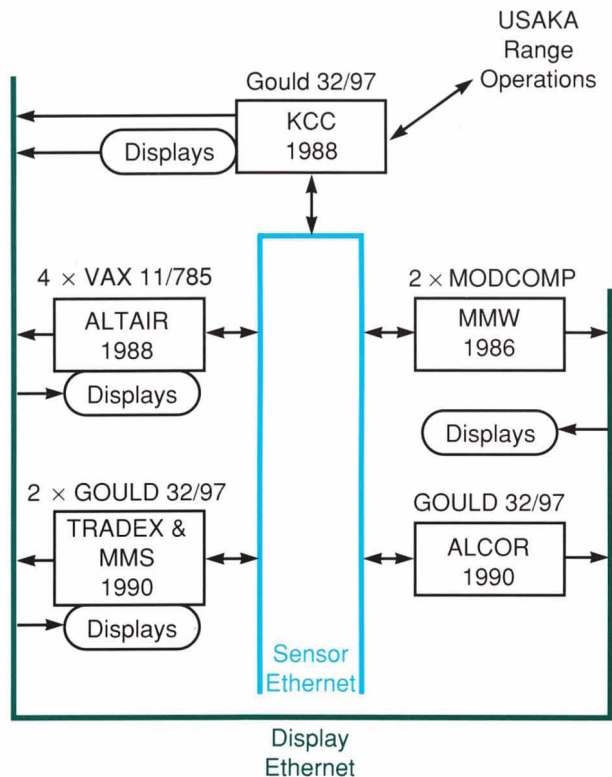

Fig. 20—Planned upgrades for the KREMS computers.

will result in an overall quadrupling of power over the original amplifier.

In summary, MMW's capabilities are being rapidly extended to acquire and track targets at long ranges. Once the modifications of Fig. 18 are fully operational, we will initiate efforts to increase the bandwidth of the 35-GHz system from 1 GHz to 2 GHz. This increase will further extend KREMS's state-of-the-art capability to explore issues of interest to the user community.

Summary

KREMS as it exists today is a flexible set of high-powered instrumentation radars. Through a concerted effort to stay abreast of user requirements, the radar system has been able to satisfy the diverse needs of the U.S. offense, defense, and intelligence communities.

Although TRADEX, ALTAIR, and ALCOR are respectively 27, 20, and 19 years old, these radars have remained at the forefront of technol-

ogy as a result of extensive and continuous upgrades over the years. With the advent of SDI testing, the radars should continue to grow and evolve.

New radar-control computers have been or are being installed throughout KREMS to provide for the implementation of extended capabilities as well as for improved reliability. Figure 20 describes the extent of the upgrade plan. New Ethernet communication systems have been installed for exchange of data between the sensors and KCC and for the transfer of display information throughout the KREMS facility. New color-graphics-display systems have been installed at KCC and at each of the individual sensors.

The upgrade of the KCC and radar-control computers began in 1985; the MMW, ALTAIR, and KCC upgrades are now complete. The ALCOR and TRADEX upgrades are scheduled for completion in 1990. The computer upgrades are providing the computational capability necessary to support multitarget tracking at ALTAIR and TRADEX, multiple-object sampling at ALCOR and MMW, increased PRF at ALCOR and TRADEX, enhanced coherent integration at each sensor, and implementation of real-time decision aids at KCC. In particular, the need for multitarget tracking and sampling and for real-time decision aids is driven by the user's need to include more targets per booster, a need that increases the complexity of reentry missions.

Waveform and signal-processing improvements are also in progress at each sensor. Additional modifications are under way to improve the radar's data quality and to replace obsolete equipment.

It is through the continuous effort to upgrade KREMS that the radar system has been able to maintain its long-standing position as the United States' most sophisticated and important R & D radar site.

Acknowledgments

The authors thank the many Lincoln Laboratory employees who have contributed to KREMS during the past 27 years, in particular those

adventuresome individuals who have lived and worked at Kwajalein. The accomplishments described in this article are the result of the hard work and dedication of these individuals.

The authors would also like to acknowledge the contributions of GE and GTE, who have built and continue to operate the KREMS radars. Finally, the authors gratefully acknowledge the United States Army Kwajalein Atoll and the United States Army Strategic Defense Command for their continuing support of

the KREMS site.

Special thanks are given to Cynthia Williams for the preparation of this manuscript, and to Richard McCauley for the photography.

References

1. G. Zorpette, "Kwajalein's New Role: Radars for SDI," *IEEE Spectrum* **26**, 64 (March 1989).
2. S.B. Bowling, R.A. Ford, and F.W. Vote, "Design of a Real-Time Imaging and Discrimination System," *Lincoln Laboratory Journal* **2**, 95 (1989).



KENNETH R. ROTH, an employee of Lincoln Laboratory for 21 years, currently manages the KREMS site. Ken received B.S., M.S., and Ph.D. degrees in aero-

and astronomical engineering from the University of Illinois. He was awarded a National Science Foundation Fellowship for his graduate work, and in 1978 he received the University of Illinois Outstanding Young Alumnus Award. His research interest is in radar systems and the analysis of high-resolution radar data. Ken has been married for 22 years; he and his wife have three children.



MICHAEL E. AUSTIN is in charge of the ALTAIR sensor at Kwajalein. Before joining the Laboratory 26 years ago, he worked for the General Motors Plasma Physics Division in Santa Barbara, Calif. He received a B.S.E.E. from the University of Notre Dame and a Sc.D. in electrical engineering from MIT. An avid genealogist in his spare time, Mike is the editor of *Austins of America*, a national newsletter that serves Austin family researchers.



DAVID J. FREDIANI Jr., Plans and Operations Section Leader of KREMS, is responsible for the overall planning, coordination, and execution of KREMS mis-

sions. David received a B.S.E.E. degree, summa cum laude, from the Lowell Technological Institute, where he was the first recipient of the Trustees Key for Academic Excellence. During his 30 years at the Laboratory, he has worked on the Lincoln Experiment Satellites (LES), Military Satellite Communications (MILSATCOM) system architecture, and the Military Strategic Tactical and Relay (MILSTAR) program. From 1984 to 1986, he was an ALTAIR system engineer responsible for directing missions and implementing upgrades.

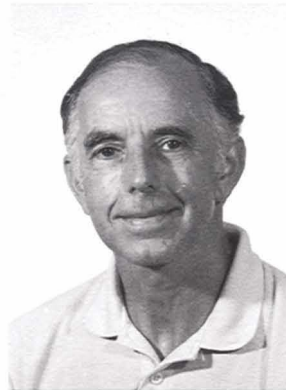

GEORGE H. KNITTEL is in charge of the TRADEX radar at Kwajalein. Before joining the Laboratory 17 years ago, George was an associate professor at the Polytechnic

Institute of Brooklyn, where he received a bachelor's degree in electrical engineering in 1955 and a Ph.D. in electromagnetics in 1969. He is a senior member of IEEE and former president of the IEEE Antennas and Propagation Society. George's work over the years includes antennas, radomes, phased-array antenna systems, polarization, and radar systems. Married for 30 years, George and his wife Mary have five children.



A. VINCENT MRSTIK is in charge of the ALCOR and MMW radars at Kwajalein. He received B.S. and M.S. degrees in electrical engineering from the University

of Illinois in 1964 and 1965, respectively, and a Ph.D. in electrical engineering from the California Institute of Technology in 1968. Upon graduating from Caltech, he joined General Research Corp. in Santa Barbara, Calif., where he worked on ground-, airborne-, and space-based radar systems and countermeasures; missile systems; data-processing systems; and emitter-location systems. In 1985, he joined RCA Corp. as a test director of the TRADEX radar at Kwajalein. His duties included the planning and execution of radar operations of ICBM test missions; the validation of test results; and the identification, development, and implementation of radar hardware and software improvements. In 1987 he joined the Laboratory, working at the ALCOR and MMW radars. Vince subsequently accepted leadership of the two radars.