

①

DTIC FILE COPY

AD-A182 398

Proceedings of the Seventeenth Annual Precise Time and Time Interval (PTTI) Applications and Planning Meeting

A meeting held at the DuPont Plaza Hotel Washington, D.C. December 3-5, 1985

Sponsored by

Naval Observatory
NASA Goddard Space Flight Center
Space and Naval Warfare Systems Command
Naval Research Laboratory
Defense Communications Agency
Chief of Naval Operations
National Bureau of Standards
Army Electronics Technology and Devices Laboratory
Rome Air Development Center
USAF Space Command

DTIC
ELECTE
S JUN 29 1987
A

This document has been approved for public release and sale; its distribution is unlimited.

DTIC
COPY
INSPECTED

THE FIRST ATOMIC CLOCK PROGRAM: NBS, 1947-1954

Paul Forman
Smithsonian Institution, Washington DC

In the years immediately after the Second World War, the techniques developed for microwave radar were applied to the stabilization of klystron oscillators by the 24GHz inversion transition of the ammonia molecule. Following these initial demonstrations of the principle, Harold Lyons, Chief of the Microwave Standards Section of the Bureau of Standards' Central Radio Propagation Laboratory, built up a comprehensive program of atomic clock development. This paper describes that program's history, scope, and accomplishments -- and its eclipse.

Keywords: microwave; ammonia clocks; cesium.

Accession For
NTIS CRA&I <input checked="" type="checkbox"/>
DTIC TAB <input type="checkbox"/>
Unannounced <input type="checkbox"/>
Justification
By
Distribution/
Availability Codes
Avail and/or
Special

Ad

Background

Hertz' experiments, 1886-88, demonstrating the reality and properties of electromagnetic waves, had been performed at the threshold of the microwave region, with waves whose lengths ranged from 3m down to 30cm. The practical development of radio communication quickly directed attention toward longer rather than shorter wavelengths, and it was almost fifty years before electronic and radio engineering began to address production and control of radio waves in the frequency range above 100MHz. Meanwhile, through the development of quantum theory, physics had established the connection between the lengths of electromagnetic waves and the energy states of atoms and molecules emitting or absorbing them.¹

Physicists thus began in the 1930s to make use of the available high frequency radio techniques, initiating spectroscopy in this original Hertzian region as a means of obtaining novel information about molecular and nuclear structure. Direct excitation and measurement of the inversion transition of the NH₃ molecule at 1.25cm (24GHz), still today one of the strongest microwave spectral lines known, formed Claude Cleeton's thesis under N.H. Williams at the University of Michigan, 1932-34. Considering how primitive was the apparatus then available for centimeter work (fig. 1), it is not altogether surprising that Cleeton's remained for more than ten years the only observation of a spectral line above a gigahertz. In the late forties, however, the situation changed dramatically. World war had brought S, X, and even K band radar into existence. At war's end the physicists took this equipment and set energetically about microwave spectroscopy of atoms and, especially, molecules (fig. 2).²

By this date the world's leading standards laboratories had already been working for decades toward the realization and international acceptance of a standard of length based on one or another atomic spectral line in the optical region. Adoption of a corresponding time unit based on the selfsame atomic vibrations/transitions -- suggested by Maxwell in 1873 -- had remained impracticable, however, due to lack of methods for counting vibrations above very moderate radio frequencies.³

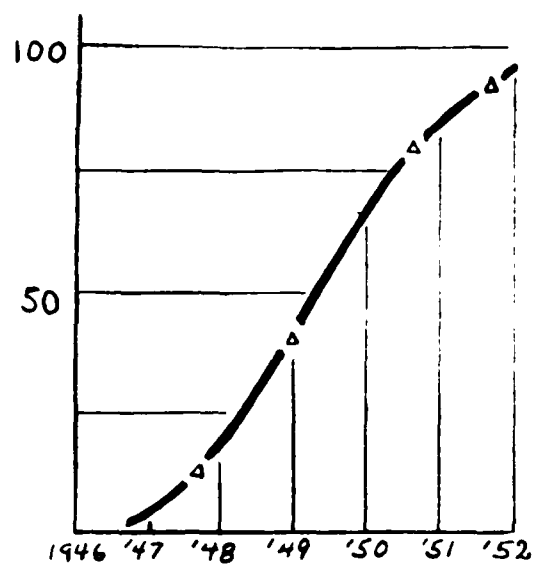

Fig. 2. Total number of molecules studied by microwave spectroscopy (from Townes, note 2).

Fig. 1. Cleeton's microwave spectrometer grating and rack of magnetron tubes, 1934.

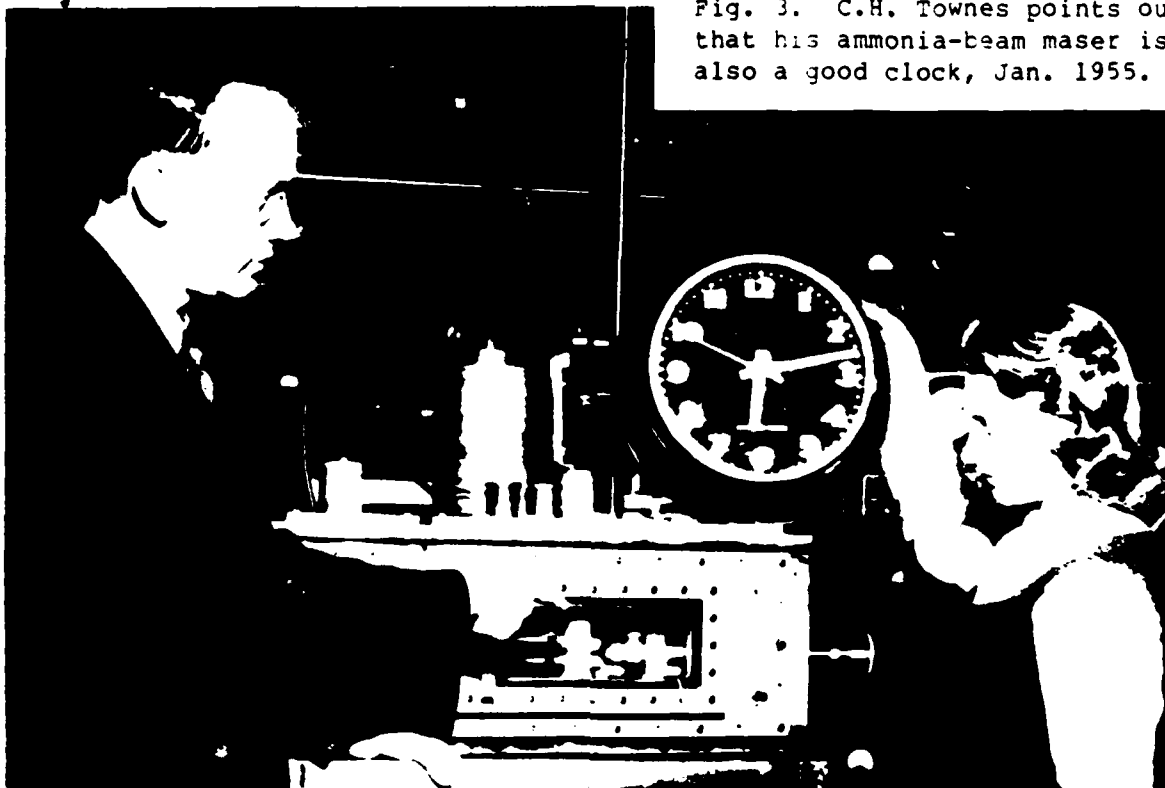
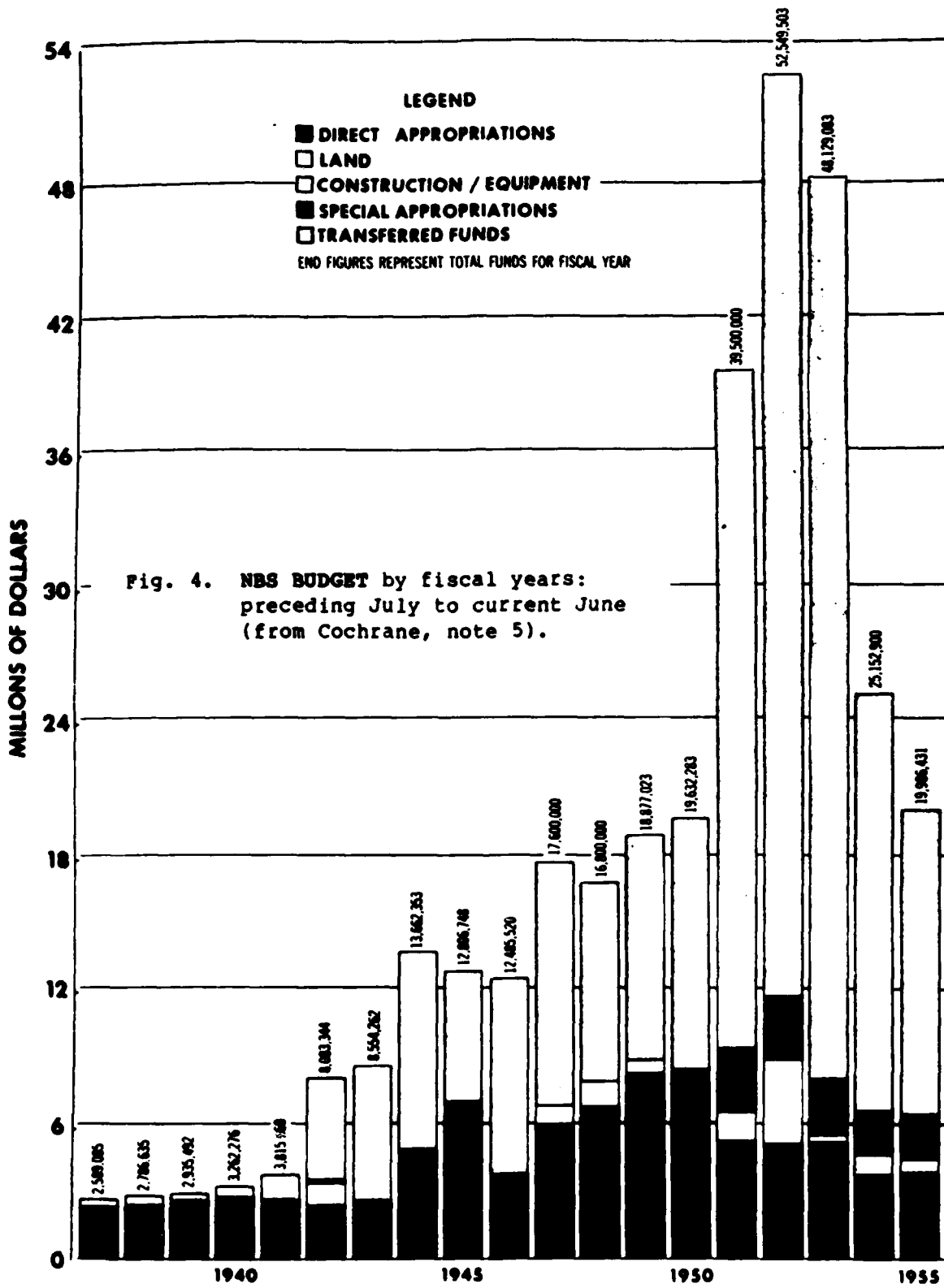

Fig. 3. C.H. Townes points out that his ammonia-beam maser is also a good clock, Jan. 1955.



NBS ANNUAL REPORTS 1902-1942 1946-1948 1954-1955 Data for fiscal years 1943-1945 1949-1951 supplied by NBS BUDGET AND MANAGEMENT DIVISION

Just before going to war, I.I. Rabi had begun to measure hyperfine energy level separations with unprecedented precision using his newly devised atomic beam magnetic resonance method. He saw then the possibility of realizing an atomic unit of time by using his spectrometer as frequency standard. Through a speech early in 1945, Rabi gave this possibility wide publicity. At this same time Charles Townes and Robert Pound, both of whom had worked with microwaves all through the war -- at Bell Labs and MIT Rad Lab, respectively -- suggested that a gas with microwave resonant energy states, confined in a cavity or waveguide, was a frequency selective system which could be used to stabilize a microwave oscillator, or more generally function as a frequency standard. Within three years frequency stabilization by a microwave absorption line had been achieved by at least five groups -- all using the 24GHz inversion transition of ammonia.⁴

NBS, CRPL, and microwave standards

It was the spring of 1942 before the Armed Services recognized the importance of systematic data on long-distance radio transmission. Then their Joint Communications Board established an Interservice Radio Propagation Laboratory at the National Bureau of Standards, whose Radio Section had long been the principal locus of such work in the U.S. The Laboratory and the Section were essentially a single entity -- formally so in May 1946 -- and thus included the Bureau's program of standard frequency transmissions and its work on radio-frequency standards.⁵

As radar was pushed up into the microwave region during the course of the war, a clear need arose for the creation and maintenance of microwave frequency standards and calibration services. Thus in 1944 a Microwave Standards Group was established in the Laboratory, and Harold Lyons placed at its head. Prior to the summer of 1942 the Bureau never had more than five persons working on radio propagation. By the summer of 1945 funds transferred from the Army and Navy had brought the staff of the IRPL over 70, and over 80 in the next fiscal year, with roughly a quarter of the Laboratory total in Lyons' Group.⁶

Lyons, born in 1913, had overlapped Cleeton a year or two in Ann Arbor. In 1939, upon completing his graduate studies, he had gone to work under Cleeton at the Naval Research Laboratory. Then in 1941 Lyons transferred to NBS, working initially on radio direction-finders under Harry Diamond. Microwaves was a new field for Lyons as for the Bureau, but he threw himself into the task with energy -- and with advice and equipment from MIT. By war's end Lyons' Group could calibrate up to 11GHz with an accuracy of a part in 10^8 , and within another year had extended this capability to 33GHz, thus covering the ammonia inversion transition. Reference frequencies for these calibrations were derived by lengthy chains of multipliers and mixers from the output of the Bureau's bank of 100KHz quartz crystal oscillators, which then constituted the National standard of frequency.⁷

This first postwar year had been used to work out with the Army and Navy an arrangement for the continuation of this Laboratory whose work had proved so generally useful. The Central Radio Propagation Laboratory was established in May 1946 as the 14th Division of the Bureau. It was, however, also overseen by a Radio Propagation Executive Council, on which sat representatives of the interested Federal agencies, chiefly the armed services. Foremost

Fig. 5. NBS, about 1950, from SE. Radio Building and tower nestled between original South and East Buildings, above, and Hydraulics Building, below.



Fig. 6. NBS' first ammonia clock, 1948/49. Layout of the chassis filling the pair of relay racks.

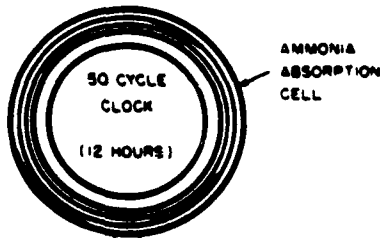

FREQUENCY DEVIATION RECORDER	FREQUENCY COMPARATOR AND DEVIATION INDICATOR
1000 CYCLE SYNCHRONOUS MOTOR CLOCK (24 HOURS)	MONITORING OSCILLOSCOPE
ELECTRONIC FREQUENCY METER (FOR DRIVING DEVIATION RECORDER)	PULSE AMPLIFIER SHAPER AND DISCRIMINATOR MIXER, IF AMPLIFIER AND PULSE SHAPER
100 KC CRYSTAL OSCILLATOR	DC CONTROL VOLTAGE INDICATOR
FREQUENCY DIVIDERS 100 KC TO 50 CPS	SWEEP GENERATOR, FM MODULATOR AND KLYSTRON FREQUENCY MULTIPLIER 270 TO 2983.8 ± 0.12 MC
REGULATED POWER SUPPLY FOR KLYSTRON TUBES	FREQUENCY MULTIPLIERS 00 KC TO 270 MC
REGULATED POWER SUPPLY PLATE & FLAMENT	ELECTRONIC VACUUM GAUGE
	REGULATED POWER SUPPLY PLATE & FLAMENT

Fig. 7. Since August 1945 Herblock had returned again and again in his Washington Post cartoons to this theme: time is running out.

Tick-Tock Tick-Tock



---from The Herblock Book (Beacon Press, 1952)

among these interested agencies was the Army Signal Corps; the Chairman of the Council was regularly chosen from among its delegates. Together, the Army and Navy provided \$500,000 for CRPL's first year of operation, July 1946 through June 1947 (FY47), but thereafter the Laboratory, qua Division 14, derived most of its funds from the Bureau's Congressional appropriation. CRPL grew very rapidly in the following three years; by FY50 its appropriated funds had reached \$3 million annually -- or half of the Bureau's total Congressional appropriation (fig. 4) -- and they remained at this level through FY53.⁸

The prosperity of the CRPL in those postwar years was due in no small part to the clout of its Executive Council, which effectively set both the program and the budget of the Laboratory, notwithstanding the vagueness of its authority. As the Council's Secretary observed, "lack of specificity ... permits the Executive Council to operate at the level of the Division Chief, the Director of the Bureau, and the Secretary of Commerce. This is a distinct advantage which more than makes up for any difficulties involved through lack of a charter."⁹

The first atomic clock

Lyons' Microwave Standards Section gradually expanded into a dozen rooms on the top floor of the Bureau's Radio Building (fig. 5), a three-story, wooden-beamed structure thrown up during the war to house the Interservice Radio Propagation Laboratory's rapidly expanding staff. The task of the Section was to establish for all frequencies upwards of 300MHz not merely frequency standards, but also standards of power, voltage, current, inductance, capacitance, impedance, attenuation, field intensity, noise, and interference. The Section was also to be responsible for development of equipment for these purposes, and, at the opposite end of the R&D scale, research on the properties of matter at microwave frequencies. Finally, it was to disseminate information nationally and internationally, and coordinate activities of industry and government in this field. Lyons had, in short, a big job -- or, alternatively, a wide field of choice.¹⁰

From the outset Lyons concentrated upon refining the specialized techniques of frequency multiplication and synthesis with the intent of extending and improving their microwave frequency standard. But at the same time, having inherited a large quantity of Rad Lab hardware, the Section undertook to master the range of techniques of microwave measurement and control. Much effort was spent in 1946/47 developing electronically stabilized klystron oscillators, following in the Rad Lab's footsteps. By the spring of 1947 plans were being laid to construct waveguide absorption cells and to enter microwave spectroscopy. The next step, to spectroscopic frequency stabilization, was a natural one; at the end of March 1948 Lyons reported that the "feasibility of locking a frequency multiplier chain to such an absorption line is being investigated."¹¹

The Bureau's approach to spectroscopic frequency stabilization advanced beyond what had been achieved elsewhere precisely in using as exciting signal -- and it would necessarily be a rather weak one -- the output of a multiplier chain that led back to a well-calibrated standard frequency source. It is this advance that made the Bureau's apparatus, once it had been achieved, count as a clock.

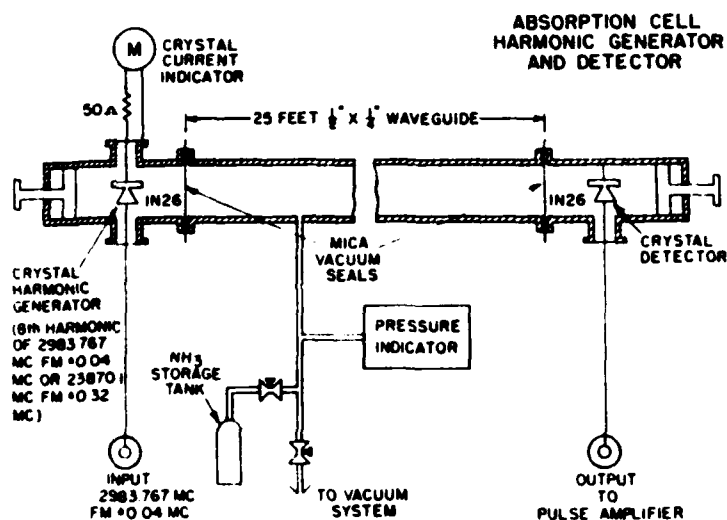
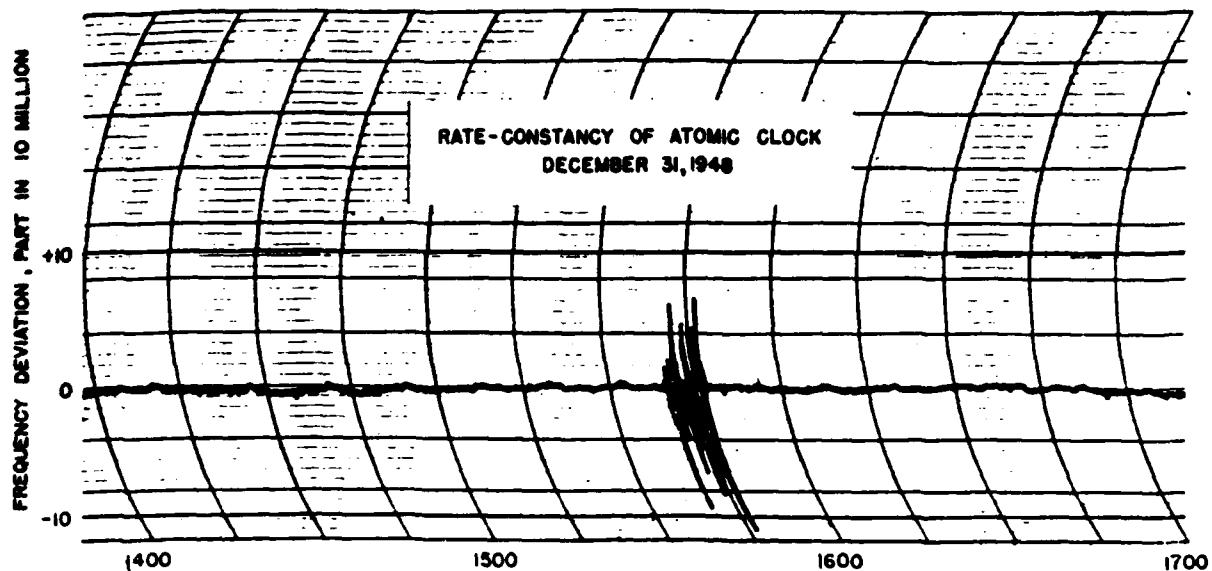

Fig. 8. Stability of NBS' 1st ammonia clock. Instability of unlocked crystal oscillator artificially augmented by "frequency 'wobbulator'."

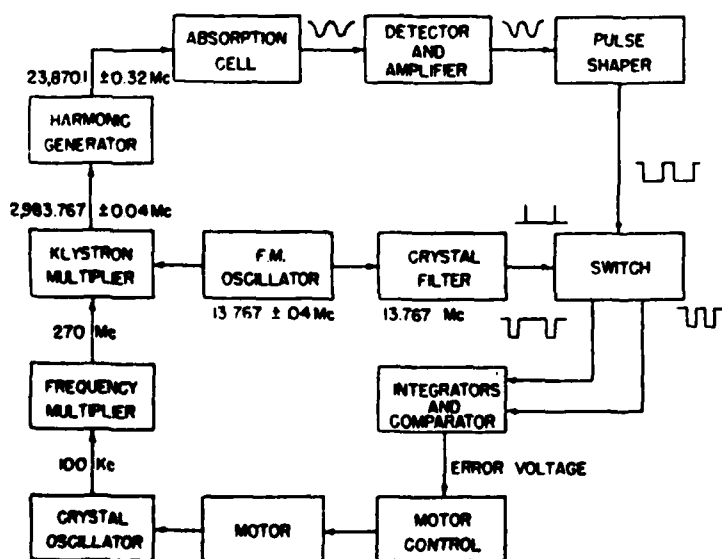

Fig. 9. Absorption cell of NBS' 2nd NH_3 clock, 1950/51. The waveguide, now in a thermostatic bath, is 5ft shorter, and the frequency modulation amplitude is three times less than in the first clock.

Fig. 10. Schematic of NBS' 2nd ammonia clock, 1950/51. The 1st clock had a more complicated discriminator, and a reactance tube as the control element of the crystal oscillator.

The rather relaxed tone of March 1948 became one of excitement and urgency at the end of the following month. Papers and discussion at the American Physical Society's spring meeting in Washington had made Lyons aware that "many research workers are now investigating this problem." Within two months Lyons and Benjamin Husten, assisted by Emory Heberling, had made their first successful experiments with an NH_3 absorption cell and a frequency discriminator. Within another two months, on August 12, 1948, their first model of an atomic clock was operating. In the following quarter, October through December,¹²

The attention of the group was largely directed towards preparing the atomic clock for public presentation, scheduled for Jan. 6, 1949. The equipment was assembled into two standard relay racks which were bolted together to form a single unit. A large 50-cycle clock was procured and mounted on top of the racks....A new spiral-shaped absorption cell was made and mounted around the 50-cycle clock....gold-plated to prevent tarnishing and to improve its appearance....A frequency "wobulator" was constructed for the purpose of deliberately forcing the frequency of the crystal oscillator by any desired amount....It is now possible to demonstrate the "locking-in" of the crystal oscillator to the ammonia line, both visually and audibly.

Lyons' showmanship was immensely successful. In the light of the atomic bomb, any further superlative atomic device was guaranteed a considerable measure of public interest. But the packaging and presentation also contributed largely to the sensation (figs 6&7). Time, the New York Times and Herald Tribune, Business Week and Newsweek, followed by many other newspapers and journals, carried the story of the atomic clock invented by Dr. Harold Lyons at the Bureau of Standards. Even the staid Review of Scientific Instruments echoed the hyperbole of the Bureau's press release: "In a radical departure from all conventional methods of measuring time, an atomic clock -- invariant with age and for the first time independent of astronomical observations...."¹³

But the Bureau's clock did not yet pose a serious threat to the world's astronomical observatories. Its stability (fig. 8) was still considerably less than that of the earth's rotation, and its uninterrupted running time was apparently but a few hours. This latter limitation was all the more embarrassing as, with public interest so high, the clock was continuously on display. Much effort went, therefore, into its improvement. Eventually it recorded runs of a few days, and an increase by a factor of two in its stability. Soon work was begun under Lauren Rueger on a second, improved model (figs 9&10), which in two years time achieved another factor of two advance in stability and reliability.¹⁴

Scope of the Bureau's program

Though Lyons' own research, from his thesis on digital counting circuits through his war work on ballistics, radio direction-finding, radar tracking, and microwave standards, had all been rather technical, he had been trained as a physicist and now he was drawn by the prospects which atomic frequency standards offered of making close contact with fundamental physics. Rapid rise of the CRPL budget between 1947 and 1950 made it feasible for Lyons to



Fig. 11. Harold Lyons with 6GHz regenerative oscillator controlled by absorption line of deuterated ammonia, about 1950.

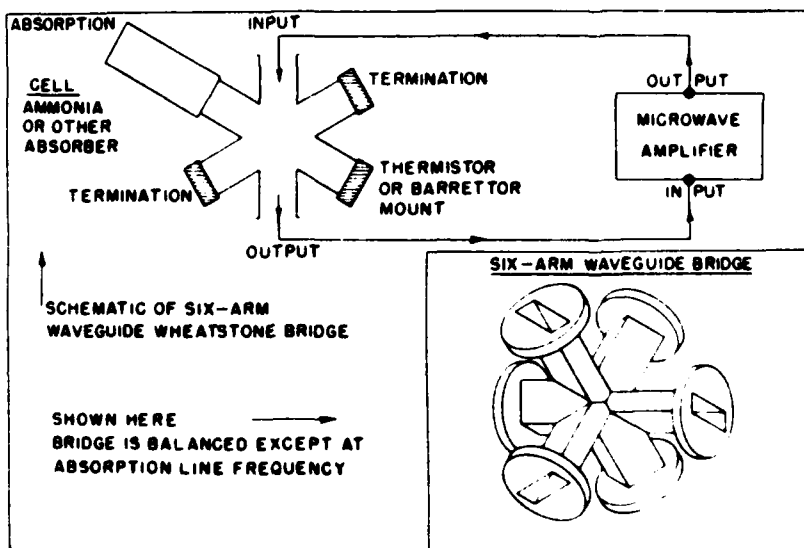

Fig. 12. ATOMIC OR ABSORPTION-LINE OSCILLATOR USING WAVEGUIDE WHEATSTONE BRIDGE

initiate and sustain a program exploring every promising line of development of spectroscopic frequency standards, as well as some ancillary microwave spectroscopy. Lyons saw his own program as part of a grander one aiming to replace all arbitrary standards -- the mean solar day, the Paris meter bar, etc. -- by atomic standards. But he was excited also by the practical potentialities of atomic clocks. In notes he prepared late in 1948 for the Bureau's public information office, Lyons anticipated the needs of "the age of interplanetary flight which is now predicted," pointing out that navigation at such great distances will require far better clocks than any then available.¹⁵

After the spring 1948 Physical Society meeting, if not sooner, Lyons was aware of the advantages of the atomic beam magnetic resonance method -- then still quite an esoteric technique -- and he recognized his need for expert advice in the field of microwave spectroscopy generally. That summer he secured as consultants both Charles Townes, who had recently moved from Bell Labs to Columbia University's Physics Department, and Polykarp Kusch, who had been there for some years as Rabi's lieutenant. One of Townes' earliest tasks was to advise on the lowering of ammonia's transition frequencies by deuterating NH_3 , for as the ammonia clock was being brought into operation, Lyons' group would gladly have sacrificed something in Q for the convenience of carrying the frequency multiplication only up to S band.¹⁶

To Kusch was assigned the task of designing an atomic clock using atomic beam techniques. On this he spent considerable effort in the winter of 1948/49, presenting his "Design Considerations" at a "Symposium on Atomic Frequency and Time Standards" which he, Lyons, and Townes organized at the Physical Society's next meeting in Washington, late in April 1949. There Townes, identified like Kusch on the printed program as affiliated with Columbia and NBS, spoke on the "Ultimate Accuracy of an Atomic Clock Using Absorption Lines," while George Gamow, then still at George Washington University, opened the symposium by contrasting "Astronomical, Radio-active, and Atomic Time," and G.M. Clemence and Paul Sollenberger of the Naval Observatory spoke on astronomical time and its determination.¹⁷

Although slated to describe "The Atomic Clock of the National Bureau of Standards" at this symposium, Lyons took the opportunity to outline his ambitious program. He dealt briefly with the ammonia clock in operation and the planned cesium-beam clock, dwelling upon his own concept of "what may be termed an atomic oscillator, that is, an oscillator controlled in frequency directly by the absorption line rather than indirectly thru a servo-mechanism." This concept of an active frequency standard, as we would say today, required that there be emission or transmission, rather than absorption, of microwave power at the resonant frequency. Lyons proposed to accomplish this by constructing a microwave analog of the Wheatstone-Meacham bridge circuit used in quartz-crystal controlled oscillators (figs 11&12). To make an atomic clock, Lyons would divide down the frequency of the output by a chain of microwave analogs of the regenerative modulator frequency dividers likewise used in quartz clocks. In fact his group had already succeeded in demonstrating one stage of such a divider, from 9.3GHz to 3.1GHz, constructed of klystron amplifiers and multipliers, with no detectible frequency slippage. It was here especially that Lyons saw a crucial advantage in the reduced resonance frequency offered by deuterated ammonia.¹⁸

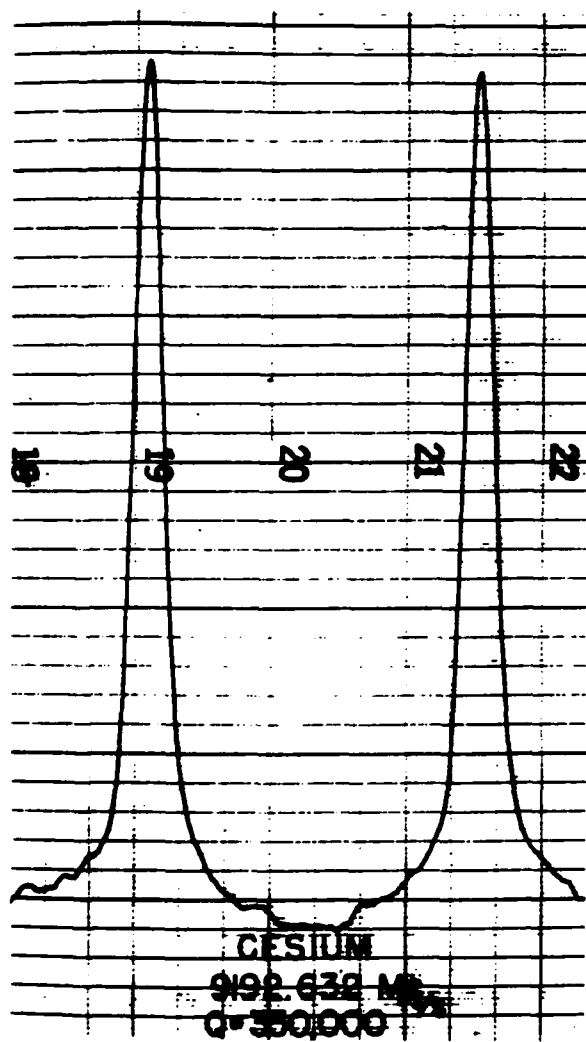
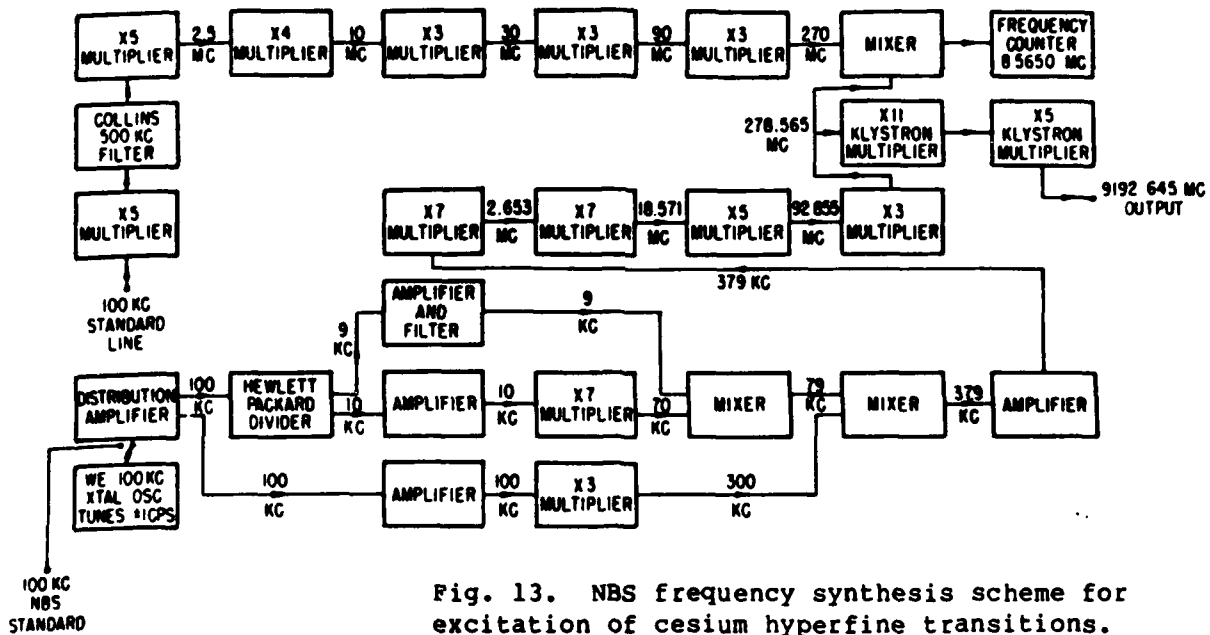

Fig. 14. "Rabi" (single cavity) resonance, NBS-I, Jan. 1952.

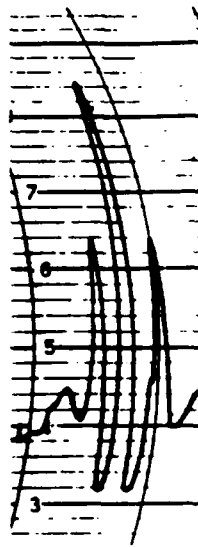
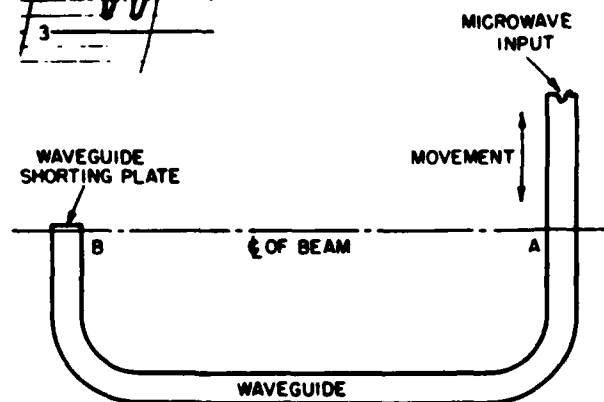

Fig. 16. "Ramsey" pattern, NBS-I, 1952.

Fig. 15. "Ramsey" microwave structure, NBS-I, 1952.



Frequent contact with Kusch and Townes kept Lyons apprised in following years of pertinent developments in fundamental physics. Hans Dehmelt's observations of nuclear electric quadrupole resonance, published in the spring of 1950, were seized upon immediately by Lyons. Here again, the relatively low frequencies -- some hundreds of megahertz -- held out new promise for his atomic oscillator & regenerative divider, while the use of small, solid samples raised hopes of a portable clock. Finally, when, late in 1954 it became clear that Townes' own "atomic oscillator" -- the ammonia beam maser -- would be an extremely stable frequency standard, Lyons got his section right to work building one.¹⁹

Work with cesium

Summarizing and supplementing a brief description I have given recently of the atomic beam work at NBS, 1948-54, I would emphasize that many of the characteristic features of cesium-beam magnetic-resonance frequency standards were foreseen by Kusch in the "Design Considerations" offered the April 1949 American Physical Society symposium. In particular, the use of permanent magnets for state selection was specified, as was the direction of their fields to give a peak of flopped atoms reaching the detector at resonance. (The prior practice of detecting a dip in the current of unflopped atoms was declared "clearly inferior.") Likewise, the now standard practice of operating with a 'C'-field of roughly 10% of the Earth's magnetic field was proposed as optimal. In concluding his considerations, Kusch found it "conceivable that sealed off atomic clocks may ultimately become available."²⁰

The cesium beam apparatus built by Jesse Sherwood, with rf system and electronics due to Lyons, Rodney Grantham, and Robert McCracken (fig. 13), was installed in the hut visible under the tower to the west of the Radio Building (fig. 5). After two years of work, cesium hyperfine lines were first observed on August 15, 1951. Late in January 1952 remarkably good results -- 9192.632 MHz -- obtained by single-cavity excitation were reported by Sherwood at the New York meeting of the American Physical Society (fig. 14). The apparatus was then converted to Ramsey excitation, with 50cm separation between the interaction regions. The relative phase of the microwave fields in the two regions was set by raising or lowering the leg of the waveguide (fig. 15), a scheme originating between Sherwood and Grantham. By the fall of 1952 the theoretically anticipated increase in Q by a factor of 100 was obtained, the central peak being only 300Hz wide (fig. 16). However, asymmetries in the Ramsey pattern, due partly perhaps to uncertainty in setting of the relative phase by this movable waveguide, held the increase in precision down below a factor of ten.²¹

The Bureau falters

Almost from the day the United States entered World War II, the bulk of the Bureau's budget had derived from the military services. Following outbreak of war in Korea in the summer of 1950, those transferred funds poured over the Bureau. Thus with the NBS' regular appropriation stagnating, its staff were increasingly shifted to military projects. Although CRPL was by far the largest of the Bureau's fourteen Divisions, its budget was relatively well shielded through FY52. But the trimming that began in 1952 was pursued in 1953 with conviction by the new Republican administration.

"Try It Again, Men. And Be Sure You Get This Answer"



Fig. 17. Herblock on the battery additive.---Copyright 1953 by Herblock in The Washington Post

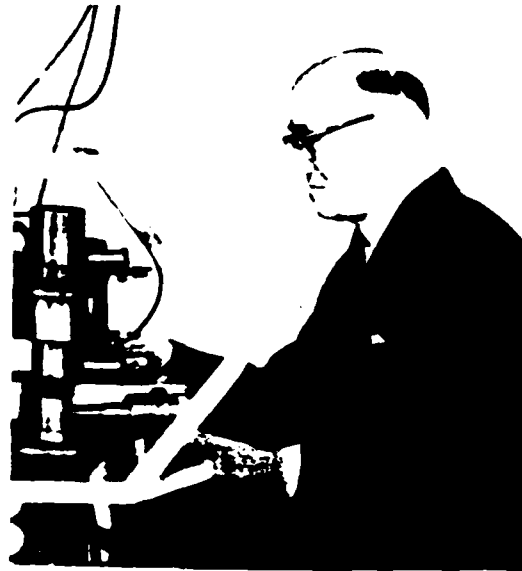
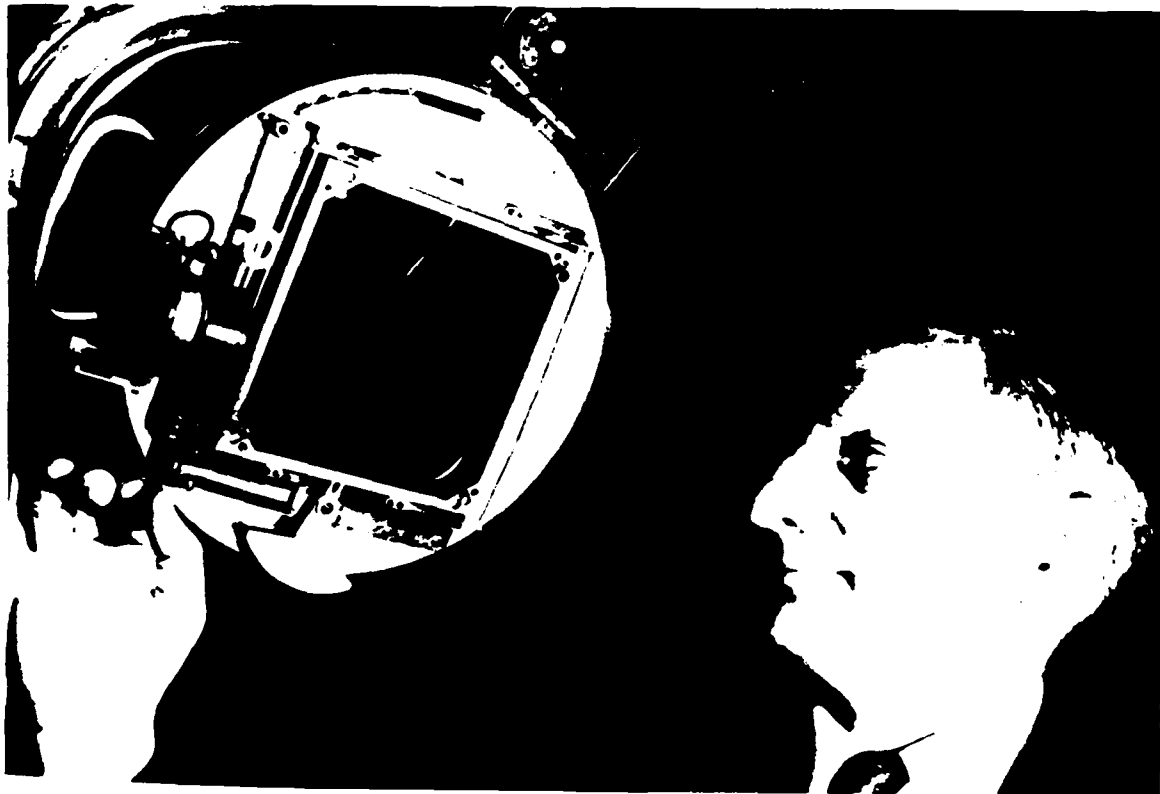

Fig. 18. Louis Essen, at the oven end of his cesium beam machine, 1955.

Fig. 19. William Markowitz with his moon-position camera to determine Ephemeris Time. (Photo 1961, courtesy USNO.)



The spring of 1953 was a bad time for the Bureau. Besides cutting NBS' budget, the new Secretary of Commerce fired its Director, who preferred scientific truth to that of the market (fig. 17). The resulting public outcry led to the appointment of a blue-ribbon committee to evaluate the Bureau. Its report deplored the "tragic" decline of basic research at NBS. Its recommendation that strictly military programs be taken over by the military was largely accepted and is reflected in the sharp drop in transferred funds in FY54 and FY55 (fig. 4). But its loud pleas for increases in the Bureau's budget and manpower went unheeded.²²

The staff of Lyons' Section had grown from 26 in 1946 and 1947 to about 50 at its peak in 1952. At this time the work on atomic clocks and ancillary microwave spectroscopy occupied the full time equivalent of 18 technical personnel, which is to say the greatest part of the increase in Section staff during the previous five years. Thereafter Lyons, like the rest of CRPL, had to face retrenchment, with the added uncertainty in program and staffing occasioned by the imminent removal of CRPL to Boulder. The cesium apparatus, in particular, ran for a month or two following Sherwood's resignation at the end of 1952, but thereafter never again in Washington.²³

Indeed, after 1952 the Bureau's atomic clock program scarcely moved forward on any front. Lyons himself deserves much of the credit for conceiving and building an ambitious program in a Section charged with many other and far more practical tasks. But Lyons must also be held responsible in some part for the strained relations with members of his scientific staff whose performance was crucial to the success of his program. Moreover, at least half the resources of that program were applied to work oriented around Lyons' own conception of an atomic oscillator feeding regenerative dividers. Had Lyons recognized after pursuing this idea for a year, or even two, that it was not so promising as it had initially seemed to him, the history of atomic clocks might have turned out a little differently.

The Bureau eclipsed

At Great Britain's National Physical Laboratory, Louis Essen (fig. 18) was immediately interested by the Bureau's first atomic clock, and followed the progress of Lyons' program closely. To a long-standing interest in quartz crystal clocks -- with significant advances in the state of the art to his credit -- Essen had added in the postwar years a mastery of the techniques of precision microwave measurements. He was thus ready to go forward into this field whenever an NPL Director would give him the resources to do so. These he finally got in the spring of 1953 -- though still a small fraction of what NBS was spending. Two years later Essen and Parry had a cesium beam machine operating with remarkable reliability. Over the next few years, a collaboration with William Markowitz of the U.S. Naval Observatory (fig. 19) produced a value for the cesium hyperfine transition frequency in terms of the most uniform time scale astronomers could offer.

Meanwhile, at MIT Jerrold Zacharias was convinced that he knew how a cesium beam clock ought to be made, even engineered and manufactured for sale. In the summer of 1954 he had a microwave oscillator locked to the output of a cesium beam apparatus -- a step that neither NBS nor NPL attempted -- and at the end of 1956 the National Co., with his guidance, completed the first batch of their "Atomichron^(R)."

NOTES

1. Heinrich Hertz, Memoirs, letters, diaries (San Francisco Press, 1977; Weinheim BRD: Physik Verlag, 1977). W.F. Snyder, Achievement in radio: seventy years of radio science and measurement at the National Bureau of Standards, NBS Special Publication 555 (Washington DC: GPO, in press).
2. C.E. Cleeton and N.H. Williams, "Electromagnetic waves of 1.1cm wavelength and the absorption spectrum of ammonia," Phys. Rev., 45: 234-237 (1934). C.H. Townes, "The present status of microwave spectroscopy," New York Academy of Sciences, Annals, 55: 745-750 (1952). For references to literature on the history of radar see: G. Shiers, Bibliography of the history of electronics (Metuchen, N.J., 1972), 184-193.
3. A sketch of the history of the definition of the meter in terms of wavelength is given in: The International Bureau of Weights and Measures, 1875-1975, NBS Special Publication 420 (Washington D.C., 1975), 72-75.
4. For further details relating to the first and the last sections of this paper, as well as for citations of the literature on the history of atomic clocks, see: P. Forman, "Atomichron^(R): the atomic clock from concept to commercial product," IEEE, Proc., 73: 1181-1204 (1985 July).
5. W.F. Snyder (note 1). R.C. Cochrane, Measures for progress: a history of the National Bureau of Standards, NBS Special Publ. 275 (Washington D.C., 1966), 404-406. NBS, CRPL, "Radio research and CRPL," 1950.7.15 (National Archives, Record Group 167, Astin Papers, Box 17).
6. CRPL, Section 9, "Annual report," 1946.6.30, 1947.6.30 (NBS, Boulder, Library).
7. CRPL, Section 9, "Radio microwave standards," 1945.7.24 (National Archives, Record Group 167, General Records of T. Howard Dellinger -- hereinafter NA DG -- Box 97); _____, "Annual report," 1946.6.30. W.D. George, H. Lyons, J.J. Freeman, J.M. Shaull, "The microwave frequency standard at the Central Radio Propagation Laboratory," Report CRPL-8-1, -9-2 (1947.5.29). Author's interviews with H. Lyons.
8. "Radio research and CRPL" (note 5) and Radio Prop. Exec. Council, minutes of meetings (NBS, Boulder, Library).
9. S.W.J. Welch, in Radio Prop. Exec. Council, minutes, 1947.12.9.
10. CRPL, Section 9, "Tentative list of projects," 1946.4.22 (NA DG, Box 97); _____, "Annual report," 1946.6.30; _____, listings of staff circa 1952 (copies kindly supplied by W.F. Snyder).
11. CRPL, Section 9, "Quarterly report," 1948.3.31 (NA DG, Box 116).
12. Lyons, handwritten additions to CRPL, Section 9, "Radio propagation activity report," 1948.4.27 (NA DG, Box 116); "Radio prop. act. report," 1948.6, and "Quart. report," 1948.9.30 and 1948.12.31 (NBS, Bldr, Libr.).

13. "Atomic Clock," RSI, 20: 141-142 (1949.2). The Bureau's release, Technical Report 1320, was reproduced in its entirety in Horological Institute of America, Journal (1949.2), 11-20; (1949.3), 7-14. For background: Paul Boyer, By the bomb's early light: American thought and culture at the dawn of the atomic age (N.Y.: Pantheon Books, 1985).
14. CRPL, Sect. 9, "Quarterly report," 1949.6.30 and 1951.9.30 (NBS, Boulder, Library). H. Lyons, "Microwave spectroscopic frequency and time standards," URSI, Proceedings of the General Assembly, Zurich 1950, vol. 8, pp. 47-57.
15. CRPL, Sect. 9, "For the information of the Technical Reports Section. Notes on the atomic clock," 36pp typescript carbon copy, dated in Lyons' hand "For Jan. 6. 1949" (NBS, Boulder, records being transferred to the National Archives). The Technical Reports Section based its press release entirely on these notes, but eliminated (as too flighty?) this one truly prescient suggestion.
16. CRPL, "Quarterly report," 1948.9.30.
17. Titles only published in Phys. Rev., 76: 161 (1949). Typescripts of Kusch's talk, along with many other manuscripts and correspondence, have been very kindly made available to me by H. Lyons.
18. Relying upon Wm. L. Laurence's account of Lyons' talk in N.Y. Times, 1949.5.1, p. 75. H. Lyons, "Microwave frequency dividers," J. of Applied Phys., 21: 59-60 (1950), dated 1949.8.8; _____, "Spectral lines as frequency standards," N.Y. Acad. of Sciences, Annals, 55: 831-871 (1952).
19. CRPL, Sect. 9, Project 14.9/10, "Report for quarter," 1950.6.30 (NBS, Boulder, records being transferred to the National Archives). Boulder Laboratories, "Semiannual report," 1954.12 (NBS Report 3521), p. 112.
20. See notes 4, 17, and 21. For background see: John S. Rigden, "The birth of the magnetic resonance method," pp. 205-237 of Observation, experiment and hypothesis in modern physical science, ed. P. Achinstein and O. Hannaway (MIT Press, 1985).
21. J.E. Sherwood, H. Lyons, R.H. McCracken, and P. Kusch, "High frequency lines in the hfs spectrum of cesium," Phys. Rev., 86: 618 (1952), merely reproduces the abstract of Sherwood's talk printed in the APS Bulletin prior to the NY meeting and contains no numbers -- neither frequency nor Q. These were published by Lyons in his review paper in the Annals of the NY Acad. of Sci. (note 18), together with essentials of Kusch's "Design Considerations" and the first results obtained (by Sherwood, principally) with Ramsey excitation. A description of the apparatus and results is given in "Cesium, atomic beam frequency standard," 19pp, 11 figs, prepared by Lyons late in 1955 with Sherwood listed as first author. Intended for the Phys. Rev., it was never actually submitted.
22. Cochrane (note 5), pp. 481-503. Radio Prop. Exec. Council, minutes, 1953.6.9, 1954.5.11.
23. CRPL, Sect. 9, "Annual report," FY46, FY47 (NA DG, Box 116); _____, "Quarterly section report," 1952.3.31 (NBS, Boulder, records being transferred to the National Archives); listings of personnel (cited in note 10).

QUESTIONS AND ANSWERS

DAVID ALLAN, NATIONAL BUREAU OF STANDARDS:
Is this all to be written down?

MR. FOREMAN:

Thank you. I am working on a book on the history of atomic clocks, a book which is advancing more slowly than I had anticipated and wished. I do however have reprints with me of an article which appeared recently in the IEEE Proceedings. It runs through this development quickly and then concentrates on the work of Zacharias and the National Company leading to the Atomichron. I can give people offprints of those and if they wish to give me their names, I would be glad to send them further pieces of the work as it is developed.